



Pasquini&Bini

where your roots are safe

Indice | Index

Foglia.....	13	Draco.....	84	Vaso Rose <i>Roses Pot</i>	132
Argo.....	14	Eracle.....	85	Ara.....	133
Sole.....	15	Super Eracle.....	86	Vaso Speciale per Agrumi <i>Special Pot for Citrus Trees</i>	134
Scudo.....	16	Eracle Fruit.....	87	Vaso per Palme <i>Special Pot for Palms</i>	134
Balena.....	17	Varia.....	88	New Pot.....	135
Boote.....	18	Ercole.....	94	Vaso Antlia <i>Antlia Pot Cover</i>	136
Triangolo.....	19	Super Ercole.....	95	Luna.....	137
Auriga.....	20	Super Ercole Quadro <i>Super Ercole Square Pot</i>	96	Cassetta Carina <i>Carina Rectangular Flower Box</i>	142
Lince.....	21	Ercole Cassetta <i>Ercole Rectangular Growing Box</i>	97	Cassetta Libra <i>Libra Flower Box</i>	143
Aquila.....	22	Miss.....	98	Maxi Cassetta <i>Maxi Flower Box</i>	146
Acquario.....	23	Super Vega.....	99	Cassiopea.....	147
Dorado.....	26	GEA vasi in bioplastica compostabile <i>GEA pots bioplastic components</i>	100	Mini-Cassiopea.....	148
Cratere.....	30	Fenice Terracotta.....	105	Pegaso.....	149
Cefeo.....	32	Fenice Nero <i>Fenice Black</i>	107	Orione.....	150
Freccia.....	33	Vaso Nero Tondo Vivaio <i>Black Round Nursery Pot</i>	110	Giove.....	151
Tucano.....	34	Vaso Nero Serie Bassa <i>Black Round Low Range</i>	111	Andromeda.....	152
Virgo.....	35	Mastelli con Manici <i>Heavy Duty Containers with handles</i>	112	Ariete.....	154
Norma.....	38	Mastelli Senza Manici <i>Heavy Duty Containers without handles</i>	113	Sirio.....	155
Idra.....	39	Mastelli Con Manici Laterali Sotto <i>Heavy Duty Containers with below handles</i>	114	Ganci per ciotole <i>Hooks For Bowls</i>	156
Millerighe.....	46	Mastelli con Manici Laterali Terracotta <i>Heavy Duty Containers Terracotta with handles</i>	114	Vaso P.B. <i>Pot P.B.</i>	158
Sagitta.....	48	Mastelloni bassi senza fori <i>Heavy Duty Squat Containers without holes</i>	115	Flori.....	159
Gemini.....	49	Mastelli Con Manici Rinforzati <i>Heavy Duty Containers with reinforced handles</i>	115	Flori Quadro <i>Flori Square Pot - Big Flori</i>	160
Berenice.....	52	Vasi per mirtilli <i>Blueberries pots</i>	117	Olanda.....	162
Vela.....	53	Perseo.....	120	Vaso a Muro <i>Wall Pot</i>	163
Lira.....	56	Cigno.....	121	Telo Antialga <i>Anti-mulch covering</i>	164
Lira Elite.....	58	Vega Terracotta.....	124	Chiodi d'acciaio <i>Steel nails</i>	164
Lira Arredo Urbano <i>Lira Street Decor</i>	62	Vega Nero <i>Vega Black</i>	126	Clips per Telo Antialga <i>Clips for antimulch covering</i>	164
Jumbo.....	63	Vaso Serra per Vega e Vaso Quadrato <i>Mini Greenhouse for Vega and Square Pot</i>	127	Carrelli porta Fenice e porta Mastelli <i>Trolley for Fenice and Big Containers</i>	165
Marte.....	64	Vaso Quadrato <i>Square Pot</i>	128	Carrello Portavasi <i>Trolley for Pots</i>	166
Diamante.....	65	Vaso Quadrato con scanalature antispiralizzazione <i>Square Pot with anti rooting grooves</i>	128	Carrello portapacchi piccolo <i>Small parcel trolley</i>	167
Sestante.....	66	Orsa.....	130	Condizioni generali di vendita <i>General sales conditions</i>	168
Ottante.....	67				
Rock.....	68				
Simil Legno <i>Wood effect</i>	69				
Venere.....	74				
Aquila Alba.....	75				
Sagitta Alba.....	76				
Millerighe Alba - Lira Alba.....	77				

where your roots
are safe

A causa della situazione instabile del mercato delle materie prime e di quello valutario, i prezzi di listino potranno variare senza preavviso.

Due to the unstable situation of both raw material market and currency market, some prices may vary without notice.

Chi siamo

Pasquini & Bini nasce nei **primi anni Sessanta** sulle rive del fiume Pescia, in Toscana.

In qualche decennio l'attività imprenditoriale si trasforma, da modesta realtà familiare, in un **punto di riferimento per lo sviluppo del vivaismo**. La produzione dei contenitori da vivaio innesca, infatti, una vera e propria **rivoluzione nel settore**: un nuovo modo di concepire la produzione e la commercializzazione delle piante.

Questa **attitudine all'innovazione** accompagna l'azienda in tutta la sua crescita, fino all'insediamento nella nuova unità produttiva ad Altopascio (LU) nel 2001 e all'**espansione internazionale**. Nel 2021, il Private Equity **Entangled Capital** entra come nuovo partner di maggioranza con l'intento di **potenziare la crescita** della società e la sua affermazione sul mercato mondiale.

Filosofia

Da sempre, dedichiamo la **massima cura ai processi**, dalla produzione alla logistica, dalla vendita all'assistenza al cliente.

Investiamo le nostre risorse per l'**acquisto di impianti all'avanguardia** e per reperire le **materie prime migliori** presenti sul mercato: presse di ultima generazione, a basso consumo energetico e in funzione 24 ore su 24. Macchinari robotizzati, stampi studiati nei minimi dettagli, polimeri di altissima qualità privi di componenti dannose per l'ambiente.

La nostra propensione all'innovazione ci ha permesso, nel corso degli anni, di **diversificare enormemente la gamma dei prodotti** e di garantire un'**elevata disponibilità** senza alterarne la caratteristica essenziale: la **qualità**.



Materiali riciclati | *Recycled materials*

Polimeri sostenibili | *Sustainable polymers*

Impianti a basso consumo | *Energy-efficient plants*

About us

Pasquini & Bini was founded in the **early 1960s** on the banks of the Pescia River, in Tuscany.

In just a few decades, the activity was transformed from a modest family business into a **landmark in the development of nursery gardening**. In fact, the production of nursery containers triggers a real revolution in the sector: a new way of conceiving the production and marketing of plants.

This **attitude for innovation** has guided the company throughout its growth, until the establishment of the new production unit in Altopascio (LU) in 2001 and **international expansion**. In 2021, Private Equity **Entangled Capital** entered as a new majority partner with the intention of **enhancing the company's growth** and its establishment on the world market.

Our Philosophy

We have always devoted the **utmost care and attention to our processes**, including production, logistics, sales and customer service.

We invest our resources in the **latest equipment** and searching the **best raw materials** on the market: state-of-the-art, energy-efficient technology running 24 hours per day, robotic machinery, mold designed down to the smallest detail, and the highest quality polymers that are free of environmentally harmful components.

Our propensity for innovation over the years has enabled us to **greatly diversify our product range** and guarantee **high availability** without altering its essential characteristic: **quality**.

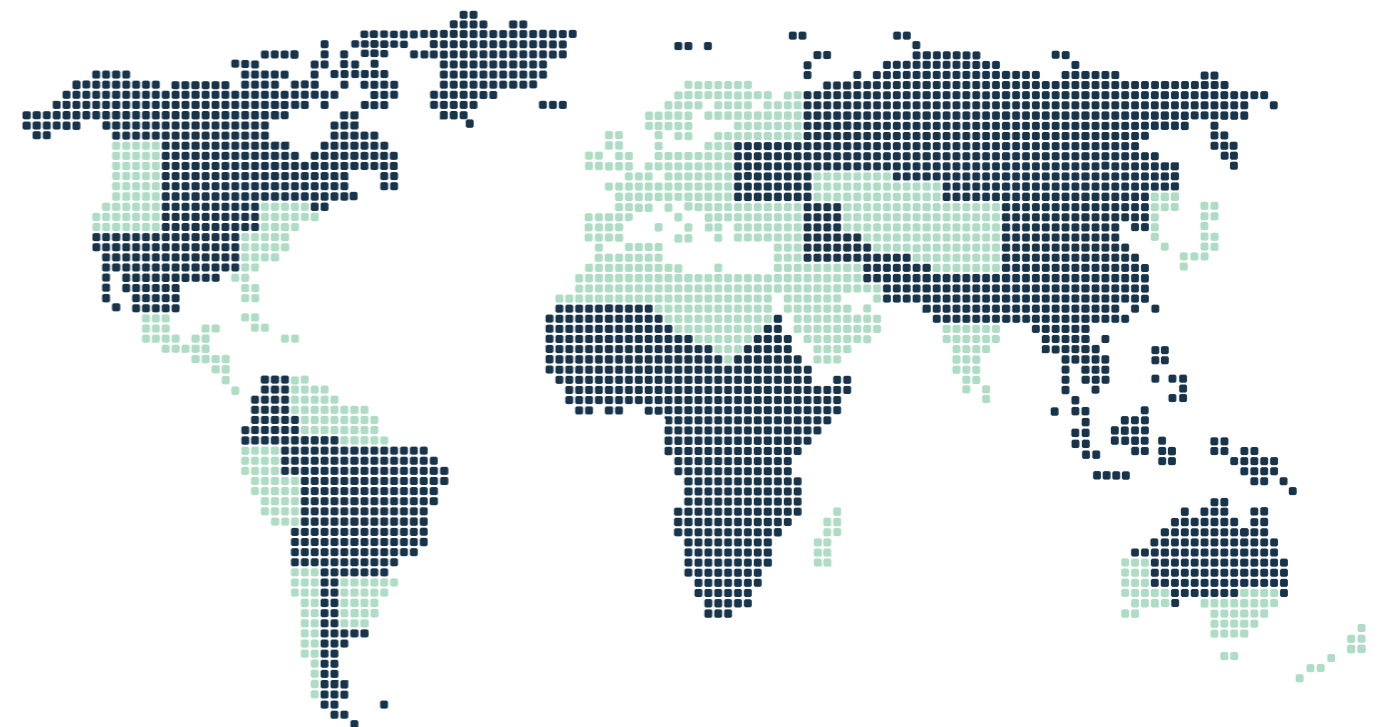

***Distribuiamo i nostri vasi
in tutto il mondo
parlando una sola lingua,
quella della qualità.***

***We distribute our pots
in the whole world,
speaking only one language,
the one of quality.***

**Lavoriamo con professionalità e
passione per far fiorire il business
della tua azienda.**

Pasquini & Bini **esporta circa il 70% della sua produzione** in oltre **60 Paesi nei 5 Continenti**, grazie anche alla collaborazione con agenti e distributori internazionali.

La nostra produzione è destinata a **mercati molto differenziati**: dal piccolo al grande vivaio, dal garden a conduzione familiare al distributore internazionale, per passare infine alle Municipalità per l'arredo urbano. Tutto questo senza perdere mai lo spirito che ha mosso questa attività fin dai suoi primi passi: il sentimento di **collaborazione, serietà e vicinanza** nei confronti dei clienti, ovunque essi siano.

**We work professionally
and passionately to make
your company's business flourish.**

Pasquini & Bini **exports about 70% of its production** to more than **60 countries in the 5 continents**, thanks also to the collaboration with international agents and distributors.

Our production is destined for **very differentiated markets**: from the small to the large nursery, from the family-run garden center to the international distributor, and finally to Municipalities for street decor. All of this without ever losing the spirit that has moved this business from its earliest beginnings: the feeling of **cooperation, seriousness** and **closeness to customers**, wherever they may be.

*Respecting nature
for a better future.*

NPB

L'innovazione firmata Pasquini & Bini Linea iniezione

I vasi della Linea NPB a iniezione sono prodotti con **macchinari altamente tecnologici** e totalmente robotizzati. Vengono impiegati solo **materiali scelti** di primissima qualità per garantire una **tenuta elevata** alle condizioni climatiche e ai processi di lavorazione del vivaismo.

Pasquini & Bini's signature innovation Injection line

NPB Line Injection pots are produced with **high-tech** and fully robotic **machinery**. Only selected materials of the highest quality are used to ensure **high durability** to climatic conditions and nursery processes.

***L'Habitat più naturale
per le tue radici.***



TEIPLAST
ROTATIONAL TUSCANY POTS

Grazie alla selezione delle **migliori materie prime** e delle più **avanzate tecnologie** produttive, abbiamo creato TEIPLAST: una gamma di prodotti di altissima qualità, dal design moderno e accattivante, rispondenti ai più alti standard secondo parametri di **leggerezza, resistenza agli urti** e agli **sbalzi di temperatura**. La migliore soluzione per l'arredo di spazi interni ed esterni che coniuga eleganza, praticità e robustezza.

Thanks to the selection of the **best raw materials** and the **most advanced production technologies**, we have created TEIPLAST: a range of products of the highest quality, modern and attractive design, that meet the highest standards for **resistance to impact, lightness and temperature changes**. The best solution for furnishing indoor and outdoor spaces that combines elegance, practicality and strength.

I NOSTRI COLORI

Contatta l'azienda e verifica la disponibilità o i tempi di attesa per i colori non presenti sull'articolo di tuo interesse.

OUR COLORS

Please contact the Company and check the stock or delivery times for those colours not available for the item you are interested in.



Nero
Black



Terra di Siena



Bronzo
Bronze



Fucsia



Tortora
Dove Grey



Terracotta



Antracite
Anthracite



Foglia

Vasi + Pouf | Pots + Pouf

SENZA FORI | NO HOLES

Questo simpatico trittico composto da due vasi di altezze diverse e da un comodo pouf darà un tocco d'allegria al tuo giardino.
 This nice triptych composed of two pots with different heights and a comfortable pouf will give your garden a touch of fun.

Art.	Massimo ingombro cm Maximum Size cm	Altezza cm Height cm
Foglia A	84,4	100,7
Foglia B	84,4	50,7
Foglia P	84,4	50,7

Per il disegno tecnico consultare la scheda prodotto su www.pasquiniibini.com

For the technical drawing consult the product data sheet on www.pasquiniibini.com

Colori disponibili | Available colors



Antracite
Anthracite



Bronzo
Bronze



Tortora
Dove Grey



FOGLIA A Alto | High



FOGLIA B Basso | Low



FOGLIA P Pouf

Argo

Cassetta | Flower box SENZA FORI | NO HOLES

La collezione Argo unisce design, eleganza e sobrietà.
The collection Argo combines design, elegance and sobriety.

Art.	Lungh. cm Length cm est. out - int. ins.	Largh. cm Width cm est. out - int. ins.	Altezza cm Height cm est. out - int. ins.	Pcs. x Pallet
ARGO	100/92	45/37	80/25	5

Colori disponibili | Available colors



Misure dello spazio portavasi | Size of the tray

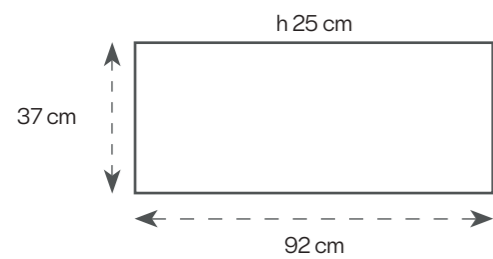

Sole

SENZA FORI | NO HOLES

Sole è un set di fioriere componibili e modulabili, a doppia parete. Un modo elegante, e soprattutto reversibile, per creare spazi verdi sia indoor che outdoor.

Sole is set of modular double-walled flower-box. An elegant, and above all reversible, way to create both indoor and outdoor green spaces.

Art.	Lungh. cm Length cm est. out - int. ins.	Largh. cm Width cm est. out - int. ins.	Altezza cm Height cm est. out - int. ins.	Pcs. x Pallet
SOLE/ANG 30	30/22	30/22	70/25	48
SOLE/CASS 100	100/90	30/22	70/25	12
SOLE/CASS 80	80/72	30/22	70/25	12
SOLE/QUA 30	30/22	30/22	70/25	48

Colori disponibili | Available colors



Scudo

Vaso Ovale | *Oval Pot* SENZA FORI | NO HOLES

Questa linea di design è adatta a dare un tocco contemporaneo a spazi interni ed esterni.
This design line is ideal to give a contemporary touch to interior and open spaces.

Art.	Lungh. cm Length cm	Largh. cm Width cm	Altezza cm Height cm	Pcs. x Pallet
SC 90	90	50	75	6

Colori disponibili | Available colors



Misure dello spazio portavasi
 Size of the tray

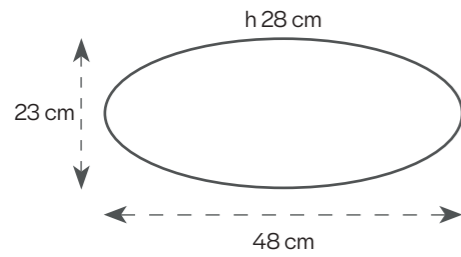

Balena

Vaso Anfora | *Anphora Pot* SENZA FORI | NO HOLES

Art.	Ø cm >	Altezza cm Height cm	Pcs. x Pallet
BA 100	100	65	3

Colori disponibili | Available colors



Misure dello spazio portavasi
 Size of the tray

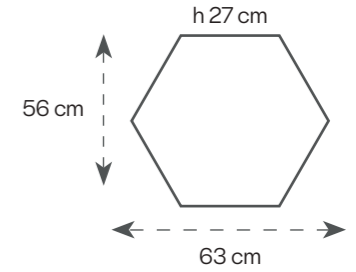

Boote

Vaso Portaoggetti Quadrato | *Square Storage Pot* SENZA FORI | NO HOLES

Art.	Lungh. cm Lenght cm est. out - int. ins.	Largh. cm Width cm est. out - int. ins.	Altezza cm Height cm	Pcs. x Pallet
BOQ 50	50/34	50/34	50	16

Coperchio | *Lid*

Art.	Lungh. cm Lenght cm	Largh. cm Width cm	Altezza cm Height cm	Pcs. x Pallet
CBOOTE	37,5	37,5	7	sfusi loose

Colori disponibili | Available colors



VASO PORTAOGGETTI
SQUARE STORAGE POT



COPERCHIO | LID

Triangolo

Vaso Torciglione | *Twisty Pot* SENZA FORI | NO HOLES

Art.	Lungh. cm Lenght cm est. out - int. ins.	Largh. cm Width cm est. out - int. ins.	Altezza cm Height cm est. out - int. ins.	Pcs. x Pallet
TR 80	44/31	44/31	80/20	18
TR 100	55/38	55/38	100/26	8

Per il disegno tecnico consultare la scheda prodotto su www.pasquiniebini.com
For the technical drawing consult the product data sheet on www.pasquiniebini.com

Colori disponibili | Available colors

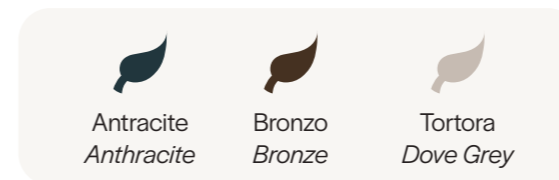

Misure dello spazio portavasi
Size of the tray

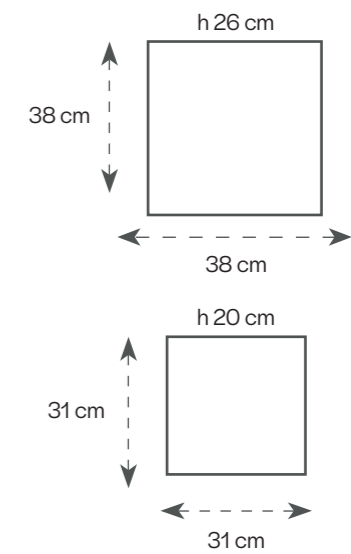

Auriga

Vaso Alto Tondo-Quadro | *High Square-Round Pot* SENZA FORI | NO HOLES

Art.	Lungh. cm Lenght cm est. out - int. ins.	Largh. cm Width cm est. out - int. ins.	Altezza cm Height cm est. out - int. ins.	Pcs. x Pallet
AU100	50/42	50/42	100/25	8

Colori disponibili | Available colors



Misure dello spazio portavasi
Size of the tray

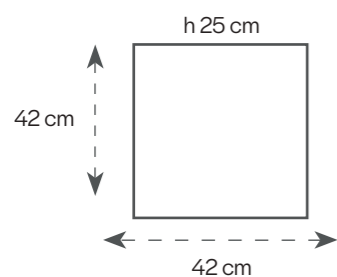

TRIANGOLO, AURIGA & AQUILA

Lince

Vaso Alto Quadro | *High Square Pot* SENZA FORI | NO HOLES

Art.	Lungh. cm Lenght cm est. out - int. ins.	Largh. cm Width cm est. out - int. ins.	Altezza cm Height cm est. out - int. ins.	Pcs. x Pallet
LINQ 100	32/26	32/26	100/25	18

Vaso Alto Tondo | *High Round Pot* SENZA FORI | NO HOLES

Art.	Ø cm >	Ø cm <	Altezza cm Height cm est. out - int. ins.	Pcs. x Pallet
LINT 100	32	26	100/25	18

Per il disegno tecnico consultare la scheda prodotto su www.pasquiniibini.com
For the technical drawing consult the product data sheet on www.pasquiniibini.com

Colori disponibili | Available colors

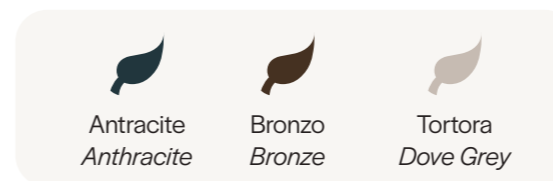

VASO ALTO QUADRO
HIGH SQUARE POT



VASO ALTO TONDO
HIGH ROUND POT

Aquila

Vaso Alto Quadro | High Square Pot

SENZA FORI | NO HOLES

Art.	Lungh. cm Length cm est. out - int. ins.	Largh. cm Width cm est. out - int. ins.	Altezza cm Height cm est. out - int. ins.	Pcs. x Pallet
VQA 60	29/22	29/22	60/18	48
VQA 80	38,4/29,5	38,4/29,5	80/24	18
VQA 100	48/37	48/37	100/29,5	8

Vaso Alto Tondo | High Round Pot

SENZA FORI | NO HOLES

Art.	Ø cm >	Ø cm <	Altezza cm Height cm est. out - int. ins.	Pcs. x Pallet
VTA 60	28,8	22,2	60/19	48
VTA 80	38,5	29,5	80/24	18
VTA 100	48	37	100/30	8

Colori disponibili | Available colors



VASO ALTO QUADRO
HIGH SQUARE POT



VASO ALTO TONDO
HIGH ROUND POT

Acquario

Vaso Tondo | Round Pot

SENZA FORI | NO HOLES

Art.	Ø cm >	Ø cm <	Altezza cm Height cm	Litri Liter	Pcs. x Pallet
ACT48	48	41	42	50	20
ACT 58	58	50	52	90	16

Sottovaso | Saucer

Art.	Ø cm >	Ø cm <	Pcs. x Pallet
SIL 41	41	37,5	sfusi loose
SIL 52	52	46,5	sfusi loose

Colori disponibili | Available colors

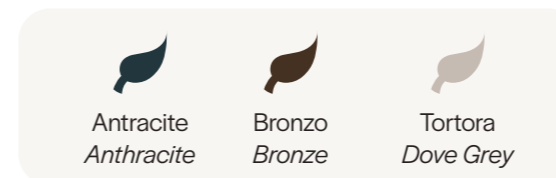

VASO TONDO
ROUND POT



SOTTOVASO
SAUCER

Acquario

Vaso Quadro | *Square Pot* SENZA FORI | NO HOLES

Art.	Lungh. cm Lenght cm est. out - int. ins.	Largh. cm Width cm est. out - int. ins.	Altezza cm Height cm	Litri Liter	Pcs. x Pallet
ACQ 40	40/34	40/34	34	36	36

Sottovaso | *Saucer*

Art.	Lungh. cm Lenght cm est. out - int. ins.	Largh. cm Width cm est. out - int. ins.	Pcs. x Pallet
SQL 35	39/34	39/34	sfusi loose

Colori disponibili | Available colors

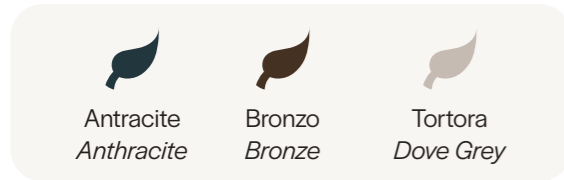

VASO QUADRO
SQUARE POT



SOTTOVASO | SAUCER



Acquario

Cassetta Rettangolare | *Flower box* SENZA FORI | NO HOLES

Art.	Lungh. cm Lenght cm est. out - int. ins.	Largh. cm Width cm est. out - int. ins.	Altezza cm Height cm	Litri Liter	Pcs. x Pallet
ACC 80	80/74	40/34	34	75	18

Sottovaso | *Saucer*

Art.	Lungh. cm Lenght cm est. out - int. ins.	Largh. cm Width cm est. out - int. ins.	Pcs. x Pallet
SCC 80	77/73	37/32,5	sfusi loose

Colori disponibili | Available colors

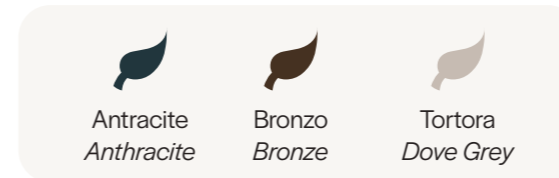

CASSETTA RETTANGOLARE
FLOWER BOX



SOTTOVASO | SAUCER

Dorado

Cassetta Rettangolare | Flower box

SENZA FORI | NO HOLES

Art.	Lungh. cm Lenght cm est. out - int. ins.	Largh. cm Width cm est. out - int. ins.	Altezza cm Height cm	Litri Liter	Pcs. x Pallet
DRC 80	80/70	40/30	34	76	18

Sottovaso | Saucer

Art.	Lungh. cm Lenght cm est. out - int. ins.	Largh. cm Width cm est. out - int. ins.
SDRC 80	70/66	31/26,5

Colori disponibili | Available colors



SOTTOVASO | SAUCER



CASSETTA RETTANGOLARE | FLOWER BOX



Dorado

Vaso Quadro | Square Pot

SENZA FORI | NO HOLES

Art.	Lungh. cm Lenght cm est. out - int. ins.	Largh. cm Width cm est. out - int. ins.	Altezza cm Height cm	Litri Liter	Pcs. x Pallet
DRQ 40	40/30	40/30	34	35	36

Sottovaso | Saucer

Art.	Lungh. cm Lenght cm est. out - int. ins.	Largh. cm Width cm est. out - int. ins.
SDRQ 40	30/26	30/26

Colori disponibili | Available colors



VASO QUADRO
SQUARE POT



SOTTOVASO | SAUCER

DORADO



Cratere

Vaso Quadro | Square pot SENZA FORI | NO HOLES

Art.	Lungh. cm Length cm est. out - int. ins.	Largh. cm Width cm est. out - int. ins.	Altezza cm Height cm	Litri Liter	Pcs. x Pallet
CRQ 40	40/32	40/32	34	34	36

Sottovaso | Saucer

Art.	Lungh. cm Length cm est. out - int. ins.	Largh. cm Width cm est. out - int. ins.
SCRQ 40	31/26	31/26

Colori disponibili | Available colors



VASO QUADRO
SQUARE POT



SOTTOVASO | SAUCER

Cratere

Vaso Tondo | Round Pot SENZA FORI | NO HOLES

Art.	Ø cm >	Ø cm <	Altezza cm Height cm	Litri Liter	Pcs. x Pallet
CRT 45	45	37	40	39	20
CRT 60	60	50	52	91	16

Sottovaso | Saucer

Art.	Ø cm >	Ø cm <
SCRT 45	36	31,5
SCRT 60	46	41

Colori disponibili | Available colors



VASO TONDO
ROUND POT



SOTTOVASO | SAUCER

Cefeo

Ciotola | Bowl SENZA FORI | NO HOLES

Art.	Ø cm >	Ø cm <	Altezza cm Height cm	Litri Liter	Pcs. x Pallet
CF 40	40	35,5	16	13	66
CF 60	60	55,5	24	45	32

Sottovaso | Saucer

Art.	Ø cm >	Ø cm <
SCF 40	33	28,5
SCF 60	43	39

Colori disponibili | Available colors



CIOTOLA
BOWL



SOTTOVASO
SAUCER



Freccia

Ciotola | Bowl SENZA FORI | NO HOLES

Art.	Lungh. cm Length cm est. out - int. ins.	Largh. cm Width cm est. out - int. ins.	Altezza cm Height cm	Litri Liter	Pcs. x Pallet
FR 40	40/33	20/13,5	16	6	96
FR 60	60/50,5	30/20,5	24	23	42

Sottovaso | Saucer

Art.	Lungh. cm Length cm est. out - int. ins.	Largh. cm Width cm est. out - int. ins.
SFR 40	34/29,5	20/15,5
SFR 60	44/40	25,5/21

Colori disponibili | Available colors



CIOTOLA
BOWL



SOTTOVASO
SAUCER



Tucano

Ciotola | *Bowl* SENZA FORI | *NO HOLES*

Ciotole lisce per dare spazio alla creatività.
Smooth bowls are ideal to give space to inventiveness.

Art.	Ø cm >	Ø cm <	Altezza cm Height cm	Litri Liter	Pcs. x Pallet
TUC 55	55	47,5	20	25	40

Sottovaso | *Saucer*

Art.	Ø cm >	Ø cm <
STUC 55	37	32

Colori disponibili | *Available colors*



CIOTOLA
BOWL



SOTTOVASO
SAUCER



Virgo

Ciotola Liscia | *Smooth Bowl* SENZA FORI | *NO HOLES*

Art.	Ø cm >	Ø cm <	Altezza cm Height cm	Litri Liter	Pcs. x Pallet	Pcs. x Box
VIR 55	55	47	17	22	88	11
VIR 85	85	73,5	27	83	12	4
VIR 100	100	86	32	149	9	3

Colori disponibili | *Available colors*

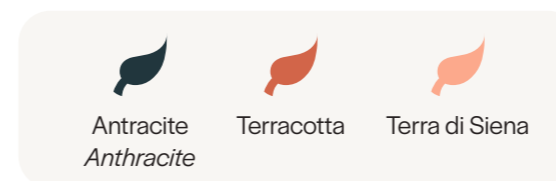

***CRATERE
CEFEO
TUCANO***



Norma

Ciotola | Bowl

Art.	Ø cm >	Ø cm <	Altezza cm Height cm	Litri Liter	Pcs. x Pallet
NOR 50	50	45	28	33	120
NOR 60	60	54,5	32	54	112

Sottovaso | Saucer

Art.	Ø cm >	Ø cm <	Pcs. x Pallet
SIL 47 (NOR 50)	47	43	sfusi loose
SIL 52 (NOR 60)	52	46,5	sfusi loose

Colori disponibili | Available colors



CIOTOLA
BOWL



SOTTOVASO
SAUCER



Idra

Vaso festonato | Pots with festoons

Art.	Ø cm >	Ø cm <	Altezza cm Height cm	Litri Liter	Pcs. x Pallet
ID 40	40	34	30	22	138
ID 45	45	39	34	32	126
ID 50	50	44	38	43	72
ID 55	55	49	45	63	64
ID 60	60	52	48	80	52
ID 65	65	58	52	102	44
ID 70	70	60	57	131	11
ID 75	75	67	60	162	10
ID 85	85	77	68	234	10

Sottovaso | Saucer

Art.	Ø cm >	Ø cm <	Pcs. x Pallet
SIL 37 (ID40-ID45)	37	34	sfusi loose
SIL 41 (ID50-ID55-ID60)	41	37,5	sfusi loose
SIL 47 (ID65-ID70)	47	43	sfusi loose
SIL 52 (ID75)	52	46,5	sfusi loose
SIL 58 (ID85)	58	53,5	sfusi loose

Colori disponibili | Available colors

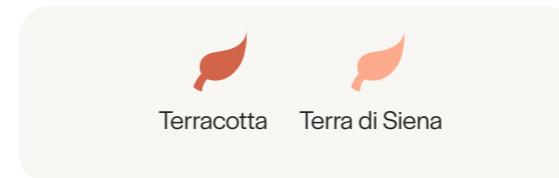

SOTTOVASO
SAUCER



Idra

Vaso Quadro Festonato | Square Pot with festoons

Art.	Lungh. cm Lenght cm est. out - int. ins.	Largh. cm Width cm est. out - int. ins.	Altezza cm Height cm	Litri Liter	Pcs. x Pallet
IDQ 40	40/32	40/32	32	33	36
IDQ 45	45/36	45/36	40	51	30

Sottovaso | Saucer

Art.	Lungh. cm Lenght cm est. out - int. ins.	Largh. cm Width cm est. out - int. ins.	Pcs. x Pallet
SQL 40 (IDQ40)	42/38	42/38	sfusi /oose
SQL 45 (IDQ45)	49/44	49/44	sfusi /oose

Colori disponibili | Available colors



Terracotta



Terra di Siena



VASO QUADRO
SQUARE POT



SOTTOVASO
SAUCER

Idra

Cassetta Festonata | Flower Box with festoons

Art.	Lungh. cm Lenght cm est. out - int. ins.	Largh. cm Width cm est. out - int. ins.	Altezza cm Height cm	Litri Liter	Pcs. x Pallet
IDC 60	60/55	27/22	27	30	42
IDC 80	80/72,5	40/33	32	69	18
IDC 100	100/90	45/36	40	120	15

Sottovaso | Saucer

Art.	Lungh. cm Lenght cm est. out - int. ins.	Largh. cm Width cm est. out - int. ins.	Pcs. x Pallet
SRD 60 (IDC60)	62,5/59	29/26	sfusi /oose
SRD 80 (IDC80)	83,5/78,5	42,5/38	sfusi /oose
SRL 100 (IDC100)	105/100	49/44,5	sfusi /oose

Colori disponibili | Available colors



Terracotta



Terra di Siena



CASSETTA RETTANGOLARE
FLOWER BOX



SOTTOVASO
SAUCER

IDRA - Vasi in stile toscano

cassetta rettangolare, vaso quadro,
vaso tondo

IDRA - Pots in Tuscan style

flower-box, square pot, round pot



Millerighe

Cassetta Rettangolare | Flower Box

Collezione Millerighe ideale all'arredo di spazi verdi e terrazzi nel rispetto della tradizione del gusto italiano.
Millerighe Collection, ideal for the furnishing of green spaces and balconies, in the respect of the Italian style.

Art.	Lungh. cm Length cm est. out - int. ins.	Largh. cm Width cm est. out - int. ins.	Altezza cm Height cm	Litri Liter	Pcs. x Pallet
MRC 70	70/64	30/24	29	52	28
MRC 80	80/72,5	35/28	32	78	18
MRC 100	100/92	45/38	38	152	18

Sottovaso | Saucer

Art.	Lungh. cm Length cm est. out - int. ins.	Largh. cm Width cm est. out - int. ins.	Pcs. x Pallet
SRL 70 (MRC70)	75/70	34,5/29,5	sfusi loose
SRL 80 (MRC80)	84,5/80	39/34,5	sfusi loose
SRL 100 (MRC100)	105/100	49/44,5	sfusi loose

Colori disponibili | Available colors

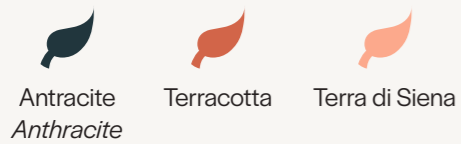

CASSETTA
RETTANGOLARE
FLOWER BOX



SOTTOVASO | SAUCER



Millerighe

Vaso Quadro | Square Pot

Art.	Lungh. cm Length cm est. out - int. ins.	Largh. cm Width cm est. out - int. ins.	Altezza cm Height cm	Litri Liter	Pcs. x Pallet
MRQ 30	30/24	30/24	29	20	84
MRQ 35	35/29	35/29	32	32	54
MRQ 45	45/38	45/38	38	66	36

Sottovaso | Saucer

Art.	Lungh. cm Length cm est. out - int. ins.	Largh. cm Width cm est. out - int. ins.	Pcs. x Pallet
SQL 30 (MRQ30)	34/29	34/29	sfusi loose
SQL 35 (MRQ35)	39/34	39/34	sfusi loose
SQL 45 (MRQ45)	49/44	49/44	sfusi loose

Colori disponibili | Available colors

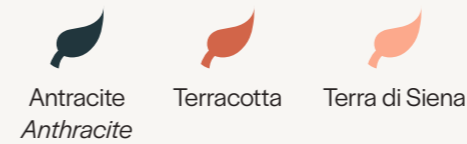

VASO QUADRO
SQUARE POT



SOTTOVASO
SAUCER



Sagitta

Cassetta Rettangolare | Flower Box

Serie liscia dallo stile attuale e moderno, dall'uso versatile sia per spazi interni che esterni.
Smooth serie, with a current and modern style, for a versatile use for the furnishing of interior and open spaces.

Art.	Lungh. cm Length cm est. out - int. ins.	Largh. cm Width cm est. out - int. ins.	Altezza cm Height cm	Litri Liter	Pcs. x Pallet
LC 50	50/45,5	22/17	23	20	56
LC 60	60/55,5	26/21,5	27,5	35	42
LC 70	70/63,5	30/24	30	45	28
LC 80	80/74	35/28,5	34	70	18
LC 100	100/91,5	45/37	43	141	15

Sottovaso | Saucer

Art.	Lungh. cm Length cm est. out - int. ins.	Largh. cm Width cm est. out - int. ins.	Pcs. x Pallet
SLC 50 (LC50)	51/47,5	22/19	sfusi loose
SLC 60 (LC60)	60,5/57,5	26/23	sfusi loose
SLC 70 (LC70)	70,5/67	30/26	sfusi loose
SLC 80 (LC80)	80,5/76,5	35,5/31	sfusi loose
SLC 100 (LC100)	101/95,5	45/39,5	sfusi loose

Colori disponibili | Available colors



CASSETTA RETTANGOLARE
FLOWER BOX



SOTTOVASO | SAUCER

Gemini

Vaso Quadrato Liscio | Smooth Square Pot

Art.	Lungh. cm Length cm est. out - int. ins.	Largh. cm Width cm est. out - int. ins.	Altezza cm Height cm	Litri Liter	Pcs. x Pallet
LQ 25	25/21,5	25/21,5	23	10	288
LQ 30	30/24	30/24	30	18	84
LQ 35	35/28,5	35/28,5	34	29	54
LQ 45	45/36,5	45/36,5	43	60	30
LQ 55	55/44	55/44	47	104	16

Sottovaso | Saucer

Art.	Lungh. cm Length cm est. out - int. ins.	Largh. cm Width cm est. out - int. ins.	Pcs. x Pallet
SQL 30 (LQ30)	34/29	34/29	sfusi loose
SQL 35 (LQ35)	39/34	39/34	sfusi loose
SQL 45 (LQ45)	49/44	49/44	sfusi loose
SQL 55 (LQ55)	56/51	56/51	sfusi loose



VASO QUADRATO LISCI
SMOOTH SQUARE POT



SOTTOVASO | SAUCER

SAGITTA GEMINI



Berenice

Cassetta Rettangolare | Flower Box SOTTOVASO INCLUSO | SAUCER INCLUDED

Si prega di contattare l'azienda per conoscere la disponibilità e tempi di consegna.
Please contact the company to know availability and delivery time.

Art.	Lungh. cm Lenght cm est. out - int. ins.	Largh. cm Width cm est. out - int. ins.	Altezza cm Height cm	Pcs. x Pallet
BERENICE	64/60,5	27/24,5	*38,50	30

*incluso sottocassetta
*saucer included

Cassetta non vendibile senza sottocassetta. | Flower box is not salable without saucer.

Colori disponibili | Available colors

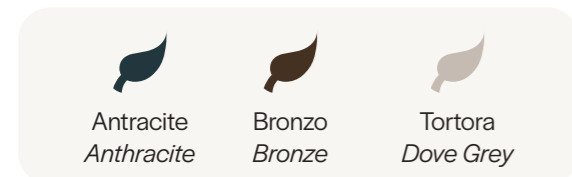

Vela

Vaso Angolare Liscio | Smooth Corner Pot

La collezione "Vela" permette di dare un tocco di eleganza e di verde anche agli angoli più nascosti.
The collection "Vela" allows to give a touch of elegance and green also to the hidden corners.

Art.	Lungh. cm Lenght cm	Largh. cm Width cm	Altezza cm Height cm	Litri Liter	Pcs. x Pallet
VL 50	50	36	56	47	24



VASO ANGOLARE LISCIO
SMOOTH CORNER POT

Vaso a Muro Liscio | Smooth Wall Pot

Art.	Lungh. cm Lenght cm	Largh. cm Width cm	Altezza cm Height cm	Litri Liter	Pcs. x Pallet
VLMU 52	52	27	56	49	24

Per il disegno tecnico consultare la scheda prodotto su www.pasquiniebini.com
For the technical drawing consult the product data sheet on www.pasquiniebini.com



VASO A MURO LISCIO
SMOOTH WALL POT

Sottovaso | Saucer

Art.	Ø cm <	Pcs. x Pallet
SVLMU (VLMU52)	31	sfusi loose
SVL (VL50)	42	sfusi loose

Colori disponibili | Available colors

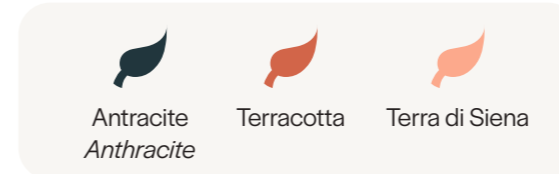

SOTTOVASO | SAUCER



SOTTOVASO | SAUCER

VELA

angolo liscio | *smooth corner*
parete liscia | *smooth wall*
sottovasi | *saucer*



Lira

Vaso Liscio | Smooth Pot

Art.	Ø cm >	Ø cm <	Altezza cm Height cm	Litri Liter	Pcs. x Pallet
LR 40	40	36	31	25	168
LR 45	45	40	35	36	162
LR 50	50	45	38	48	100
LR 55	55	50	41	64	88
LR 60	60	54	45	84	80
LR 65	65	58	48	105	72
LR 70	70	63	50	127	18
LR 75	75	67	55	161	17
LR 85	85	76	61	223	15
LR 95	95	85	68	325	13

Supporto per vasi e cassette | Supports for pots and flower box

Art.	Lungh. cm Length cm	Altezza cm Height cm
PIE	18	5

Colori disponibili | Available colors



VASO LISCIO
SMOOTH POT



SUPPORTI
SUPPORTS



Sottovaso | Saucer

Art.	Ø cm >	Ø cm <	Pcs. x Pallet
SIL 37 (LR40-LR45)	37	34	sfusi loose
SIL 41 (LR50)	41	37,5	sfusi loose
SIL 47 (LR55-LR60)	47	43	sfusi loose
SIL 52 (LR65)	52	46,5	sfusi loose
SIL 58 (LR70-LR75)	58	53,5	sfusi loose
SIL 65 (LR85)	65	60	sfusi loose

Colori disponibili | Available colors



SOTTOVASO | SAUCER



Lira Elite

Vaso Liscio | *Smooth Pot* CON FORI | WITH HOLES

L'unione tra il Design Moderno del Vaso Lira e le dimensioni necessarie per l'arredo urbano.
The perfect match of the Modern Design of our Lira pot with the big dimensions essential for the street decor.

Art.	Ø cm >	Ø cm <	Altezza cm Height cm	Litri Liter	Pcs. x Pallet
LRE 28	28,5	25	26,2	8	320
LRE 40	40	35	37	25	120
LRE 50	50	44	46	52	60
LRE 60	60	53	55	95	48
LRE 70	70	62	64	148	10
LRE 80	80	71	73	220	8

Colori disponibili | Available colors



LIRA ELITE

Vaso Liscio | *Smooth Pot* SENZA FORI | NO HOLES

Art.	Ø cm >	Ø cm <	Altezza cm Height cm	Litri Liter	Pcs. x Pallet
LRE 100	100	90	91,5	430	6
LRE 120	120	108	110	765	5
LRE 140	140	127	128,5	1215	4



DIAMANTE MARTE



Lira

Vaso Liscio | *Smooth Pot* SENZA FORI | *NO HOLES*

Art.	Ø cm >	Ø cm <	Altezza cm Height cm	Litri Liter	Pcs. x Pallet
LR 105	105	96	70	400	10
LR 135	135	120	80	700	9
LR 155	155	140	90	1100	8
LR 175	175	159,5	100	1500	8
LR 200	200	184	110	2200	-
LR 230	230	214	120	3250	-

Colori disponibili | *Available colors*



Antracite
Anthracite



Terra di Siena

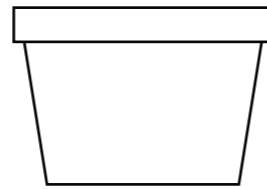
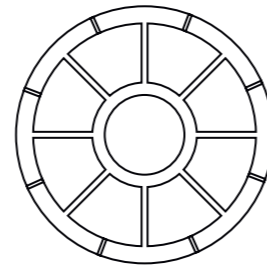

(LR 105 - LR 135)

Fondo rinforzato
Reinforced bottom

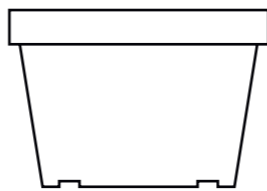
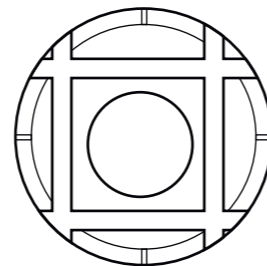

(LR 155 - LR 175 - LR 200 - LR 230)

Fondo ergonomico
per presa con muletto
*Ergonomic bottom suited
to be lifted with the forklift*



LIRA



Jumbo

Vaso Liscio- Fondo Rinforzato | *Smooth Pot - Reinforced Bottom*

Art.	Ø cm >	Ø cm <	Altezza cm Height cm est. out - int. ins.	Litri Liter	Pcs. x Pallet
JUMBO 40	40	35	31/29	24	72
JUMBO 45	45	39	34,5/34	35	44
JUMBO 50	50	44	38/36	50	40
JUMBO 55	55	48	42/40	70	36
JUMBO 63	63	55	44,5/42	100	32
JUMBO 70	70	61	47/44,5	125	7
JUMBO 80	80	71	50/46	165	6
JUMBO 90	90	81	52/47	215	6
JUMBO 100	100	90	56/50	285	6
JUMBO 110	110	101	64/56	390	6
JUMBO 122	122	110	67/60	500	6
JUMBO 145	145	130	74/67	800	5
JUMBO 160	160	145	83/73	1250	4
JUMBO 185	185	170	91/80	1650	4

Colore disponibile | *Available color*



Bronzo
Bronze



JUMBO



Marte

Vaso Liscio - Fondo Rinforzato | *Smooth Pot - Reinforced Bottom*

DESIGN BY LORENZO PELOSINI

Art.	Ø cm >	Altezza cm Height cm	Litri Liter
MAR 140	140	100	900

Per il disegno tecnico consultare la scheda prodotto su www.pasquini&bini.com
 For the technical drawing consult the product data sheet on www.pasquini&bini.com

Colori disponibili | Available colors



Fondo ergonomico per la presa con muletto.
 Ergonomic bottom suited to be lifted with the forklift.



MARTE



Diamante

Fioriera | *Flower Box*

DESIGN BY MARIA LUISA MALPELO

Un prodotto versatile per permettere tutte le combinazioni che vuoi.
 A versatile product to allow as many combinations as you want.

Art.	Lungh. cm Length cm	Largh. cm Width cm	Altezza cm Height cm
DMF 116	116	58	105



FIORIERA
 FLOWER BOX

Portvaso | *Tray*

Lungh. cm Length cm	Altezza cm Height cm
108	30

Seduta | *Sitting*

Art.	Lungh. cm Length cm	Largh. cm Width cm	Altezza cm Height cm
DMS 112	112	85	55

Per il disegno tecnico consultare la scheda prodotto su www.pasquini&bini.com
 For the technical drawing consult the product data sheet on www.pasquini&bini.com

Colori disponibili | Available colors

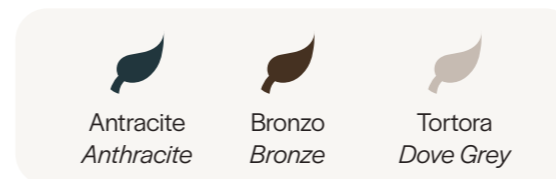

SEDUTA
 SITTING



Sestante

Vaso per arredo urbano | *Pot for Street Decor* SENZA FORI | NO HOLES

Art.	Ø cm >	Ø cm <	Altezza cm Height cm	Litri Liter	Pcs. x Pallet
SESTO 116	116	94	53/48*	470	4

*altezza interna utilizzabile 45 cm
*usable internal height 45 cm

Colori disponibili | Available colors

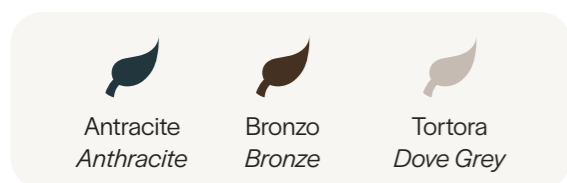

TORTORA
DOVE GREY



BRONZO
BRONZE



ANTRACITE
ANTHRACITE



Ottante

SENZA FORI | NO HOLES

Fondo ergonomico per presa con muletto.
Ergonomic bottom suitable to be lifted with the forklift.

Art.	Ø cm >	Ø cm <	Altezza cm Height cm	Litri Liter
OTT 115	115	90	80	400

Colori disponibili | Available colors



OTTANTE



Rock

Vaso poligonale | *Poligonal Pot* SENZA FORI | *NO HOLES*

Art. Ø cm > Ø cm < Altezza cm | Height cm

ROCK 1054 105,4 87 104,4

Per il disegno tecnico consultare la scheda prodotto su www.pasquini&bini.com
For the technical drawing consult the product data sheet on www.pasquini&bini.com

Colori disponibili | Available colors



Antracite
Anthracite



Bronzo
Bronze



Tortora
Dove Grey



ROCK



Simil legno | *Wood effect*

Cassa Rettangolare | *Rectangular Box*

SENZA FORI con doppio bordo | *NO HOLES with double rim*

Art.	Lungh. cm Length cm est. out - int. ins.	Largh. cm Width cm est. out - int. ins.	Altezza cm Height cm est. out - int. ins.	Litri Liter	Pcs. x Pallet
LEC 95	95/85	47/38	39/33	102	15

Cassa Quadrata | *Square Box*

SENZA FORI con doppio bordo | *NO HOLES with double rim*

Art.	Lungh. cm Length cm est. out - int. ins.	Largh. cm Width cm est. out - int. ins.	Altezza cm Height cm est. out - int. ins.	Litri Liter	Pcs. x Pallet
LEQ 47	47/38	47/38	39/33	52	20
LEQ 54	54/44	54/44	47/41	65	20

CASSETTA RETTANGOLARE | *RECTANGULAR BOX*



CASSETTA QUADRATA | *SQUARE BOX*



Simil legno | Wood effect

Seduta | Seat

Art.	Lungh. cm Lenght cm	Largh. cm Width cm	Altezza cm Height cm
LES 60	60	60	48

Vaso Angolare | Corner Pot

Art.	Lungh. cm Lenght cm est. out - int. ins.	Largh. cm Width cm est. out - int. ins.	Altezza cm Height cm est. out - int. ins.
LEF 60	60/44	60/44	48/33,5

Vaso Con Seduta | Seating Pot

Art.	Lungh. cm Lenght cm est. out - int. ins.	Largh. cm Width cm est. out - int. ins.	Altezza cm Height cm est. out - int. ins.
LEPA 110	110/52	60/44	48/33,5



SEDUTA | SEAT



VASO ANGOLARE | CORNER POT



VASO CON SEDUTA | SEATING POT



EFFETTO LEGNO WOOD EFFECT



Venere

Vaso Liscio Lucido | *Shiny Smooth Pot*

La nostra serie Venere è il frutto di accurate ricerche di speciali materie prime che, utilizzate con un corretto processo produttivo e con stampi adeguati, ne fanno un prodotto di altissima qualità, adatto all'arredo di interni.

Our collection Venere is the result of an accurate research of special raw materials, which used with a proper manufacturing process, make it a high quality product, ideal for the furnishing of internal spaces.

Art.	Ø cm >	Ø cm <	Altezza cm Height cm	Litri Liter	Pcs. x Pallet
VEN 50	50	45	38	48	100
VEN 55	55	50	41	64	88
VEN 60	60	54	45	84	80

Sottovaso | *Saucer*

Art.	Ø cm >	Ø cm <	Pcs. x Pallet
SVEN 41 (VEN50)	41	36,5	sfusi loose
SVEN 47 (VEN55-VEN60)	47	43	sfusi loose

Colori disponibili | Available colors



Nero
Black



Bianco
White



VASO LISCIO LUCIDO
SHINY SMOOTH POT



SOTTOVASO
SAUCER



ALBA - VASI BIANCHI | ALBA - WHITE POTS

TEIPLAST

Aquila Alba

Vaso Alto Tondo | *High Round Pot* SENZA FORI | NO HOLES

Art.	Ø cm >	Ø cm <	Altezza cm Height cm est. out - int. ins.	Pcs. x Pallet
VTA 80	38,5	29,5	80/24	18
VTA 100	48	37	100/30	8

Vaso Alto Quadro | *High Square Pot* SENZA FORI | NO HOLES

Art.	Lungh. cm Length cm est. out - int. ins.	Largh. cm Width cm est. out - int. ins.	Altezza cm Height cm est. out - int. ins.	Pcs. x Pallet
VQA 80	38,4/29,5	38,4/29,5	80/24	18
VQA 100	48/37	48/37	100/29,5	8

VASO TONDO ALTO
HIGH ROUND POT



VASO QUADRATO ALTO
HIGH SQUARE POT



Sagitta Alba

Cassetta Rettangolare | Flower Box

SENZA FORI | NO HOLES

Art.	Lungh. cm Length cm est. out - int. ins.	Largh. cm Width cm est. out - int. ins.	Altezza cm Height cm	Litri Liter	Pcs. x Pallet
LC 80	80/74	35/28,5	34	70	18
LC 100	100/91,5	45/37	43	141	15



SAGITTA ALBA



Millerighe Alba

Cassetta Rettangolare | Flower Box

SENZA FORI | NO HOLES

Art.	Lungh. cm Length cm est. out - int. ins.	Largh. cm Width cm est. out - int. ins.	Altezza cm Height cm	Litri Liter	Pcs. x Pallet
MRC 80	80/72,5	35/28	32	78	18
MRC 100	100/92	45/38	38	152	18



MILLERIGHE ALBA

Lira Alba

Vaso Liscio | Smooth Pot

SENZA FORI | NO HOLES

Art.	Ø cm >	Ø cm <	Altezza cm Height cm	Litri Liter	Pcs. x Pallet
LR 40	40	36	31	25	168
LR 45	45	40	35	36	162
LR 50	50	45	38	48	100
LR 55	55	50	41	64	88
LR 60	60	54	45	84	80
LR 65	65	58	48	105	72



LIRA ALBA

NPB

LINEA INIEZIONE

Cura, progettazione, tecnologia e soprattutto le materie prime migliori sul mercato, da quelle rigenerate ai polimeri vergini. Che siano per il vivaio o il giardinaggio, per la floricoltura o la coltivazione idroponica, resistenza e solidità sono i comuni denominatori per i nostri vasi ad iniezione.



Certificazione di riciclabilità e rilevabile NIR (senza Carbon Black)

INJECTION LINE

Care, research, technology and, above all, the best raw materials we can find on the market from the regenerated ones to the virgin polymers.

For nursery or gardening, flower-growing or hydroponic plantation, strength and solidity are the common denominators for the pots of our injection line.



Certification of recyclability and NIR detectable (Carbon Black free)



Draco

Il nuovo vaso con l'innovativo sistema anti-spiralizzazione

Il sistema è posto sulla parete interna ed è costituito da **nervature longitudinali** in grado, non solo di bloccare la **crescita circolare delle radici**, ma di **indirizzare** le stesse in una **corretta crescita verticale**. Il fondo è dotato di aperture che consentono un **perfetto drenaggio**, lasciando sempre il **giusto grado di umidità** all'apparato radicale e impedendo la **formazione di ristagni**. Lateralmente, il fondo si protrae in robusti piedi così da poter restare **rialzato da terra** rendendo l'appoggio del vaso molto stabile. La distanza da terra permette alla pianta di **ossigenarsi al meglio** e **facilita il drenaggio**, mantenendo l'apparato radicale **più isolato** e **preservato dagli sbalzi termici**.

The new pot with innovative anti-spiral system

The **anti-spiral system** is placed on the internal wall and consisting of **ribs running lengthwise** capable not only to stop the **circular growth of the roots** but to **direct them** in a **correct vertical growth**. The bottom has holes which allow **perfect drainage**, always leaving the right degree of humidity to the root system and preventing the **formation of stagnation**.

Laterally, the bottom extends into sturdy feet so as to remain **raised from the ground** making the pot's support very stable. The distance from the ground is essential **to allow the plant to oxygenate itself and facilitate drainage**; in addition, the root system remains more **isolated and preserved from temperature changes**.

Esternamente può essere facilmente personalizzato.

Externally it can be easily customized.



Bordo robusto che permette la movimentazione con rastrelliere meccaniche. Materiale resistente agli urti e alle sollecitazioni meccaniche.
Sturdy rim for handling with mechanical racks. Material resistant to impact and to the mechanical stress.

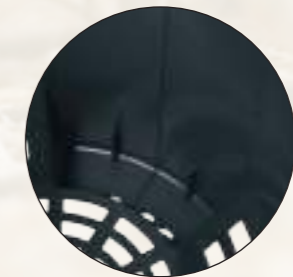

Innovativo sistema anti-spiralizzazione che, grazie alle nervature interne, indirizza nel modo corretto la crescita delle radici.
Innovative antispiralization system which, thanks to the internal ribs, directs the growth of the root in the correct way.

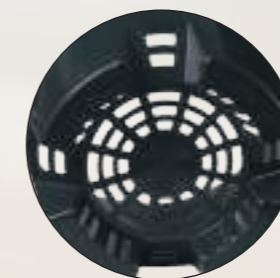

Aperture pari al 35% della superficie del fondo.
Openings equal to 35% of surface of the bottom.



Vaso molto rialzato dal suolo ma con grande stabilità.
Very raised pot from the ground but with great stability.

DRACO è un vaso facilmente movimentabile con i muletti dotati di rastrelliera, grazie al design del suo robusto bordo. Facile da impilare ed estremamente resistente, è in grado di poter sopportare i ripetuti e costanti stress da vivaio.

Questo vaso darà eccellenti risultati in **vivaio**, nella **coltivazione idroponica** e nella produzione di **giovani piante di mirtillo**.

DRACO is a pot that can be easily moved with forklifts equipped with a rack, thanks to the sturdy rim; it is easy to stack, extremely resistant, able to withstand repeated and constant nursery stresses.

This pot will give excellent results in the **nursery**, in **hydroponic cultivation** and in producing **young blueberry plants**.



- 
OTTIMIZZAZIONE DEI TEMPI DI PRODUZIONE DELLA PIANTA
OPTIMIZATION OF PLANT PRODUCTION TIMES
- 
MINOR IMPATTO AMBIENTALE RIDOTTO IMPIEGO DI ACQUA E PRODOTTI FITOSANITARI
LESS ENVIRONMENTAL IMPACT REDUCED USE OF WATER AND PHYTOSANITARY PRODUCTS
- 
PERFETTO DRENAGGIO E MIGLIORE OSSIGENAZIONE APERTURE SUL 100% DELLA SUPERFICIE DEL FONDO
PERFECT DRAINAGE AND BETTER OXYGENATION OPENINGS ON 100% OF THE BOTTOM SURFACE
- 
APPARATO RADICALE PRESERVATO DAGLI SBALZI TERMICI
ROOT SYSTEM PRESERVED FROM TEMPERATURE LEAPS
- 
CRESCITA VERTICALE DELLE RADICI
VERTICAL GROWTH OF THE ROOTS
- 
PIÙ FACILE DA IMPILARE CON CONSEGUENTE RIDUZIONE DEGLI ONERI DI TRASPORTO
EASIER TO STACK WITH A CONSEQUENT REDUCTION OF TRANSPORT COST
- 
ESTETICA PIACEVOLE E REALIZZABILE IN MOLTEPLICI COLORI
PLEASANT AESTHETICS AND AVAILABLE IN MULTIPLE COLORS
- 
MIGLIORE CAPACITÀ DI FRUTTIFICAZIONE DELLA PIANTA
BETTER FRUCTIFICATION CAPACITY OF THE PLANT

Draco

Art.	Ø cm >	Altezza cm Height cm	Litri Liter	Pcs. x Pallet
DRA 17	17	15	2,3	3360
DRA 19	19	16,5	3	3360
DRA 22	22	19,5	5	2100
DRA 25	25,5	23	8,5	1400

Infine, per la vendita delle piante manca solo un tocco glossy: il coprivaso.
 È leggerissimo con una finitura lucida e brillante, realizzabile su richiesta in tantissimi colori moda.
At last only a glossy touch is missing for the sale of your plants: the POT COVER.
It is very light with a shine and brilliant finish, available in many fashion colors on request.

Coprivaso | Pot cover

Art.	Ø cm >	Altezza cm Height cm	Litri Liter
CP DRACO 25	26	23,8	per Draco 25 for Draco 25



Qui trovi il video dedicato al vaso Draco.

Here you can find the video dedicated to Draco pot.



Eracle

Eracle, il vaso ideato per far sorridere le radici delle vostre piante. L'antispiralizzazione e i "piedi" che staccano il fondo del vaso dal terreno, garantiscono una perfetta combinazione di aria e acqua e permettono una crescita ottimale delle radici.

Eracle, the pot that makes the roots of your plants laugh. The non rooting-circling function and the "FEET" that space the bottom of the pot from the ground, guarantee a perfect combination of air and water and an optimal growth of the roots.

Art.	Ø cm >	Ø cm <	Altezza cm Height cm	Litri Liter	Pcs. x Pallet
ER 16	17	16	15	2	5250
ER 18	19	18	16	3	4200
ER 20	21	20	20	5	3000
ER 22	24	22	21,5	7	2400
ER 24	26,5	24	23,5	9	2000
ER 29	31,5	29	29	15	1280
ER 31	34	31	30,5	18	1120
ER 35	39	35	32	25	520
ER 40	43	40	37	35	480



Super Eracle

Dopo i successi ottenuti con le coltivazioni nei vasi ERACLE, Pasquini & Bini ha ideato SUPER-ERACLE. Il vaso SUPER-ERACLE è ancora più performante grazie alla migliore aerazione data dalle numerose aperture del fondo e ai piedi che lo distanziano maggiormente dal suolo. In questo modo, l'apparato radicale "respira" e la pianta cresce più forte e sana.

After the successes achieved with the cultivation in ERACLE pots, Pasquini & Bini has developed SUPER-ERACLE. The SUPER-ERACLE pot is even more performing thanks to the better ventilation given by the numerous openings of the bottom and the feet that distance it more from the ground. In this way, the root system "breathes" and the plant grows stronger and healthier.

Art.	Ø cm >	Ø cm <	Altezza cm Height cm	Litri Liter	Pcs. x Pallet
SER 50	51	46	40	50	350
SER 75	60	55	43,5	75	240



Eracle Fruit

Vaso lungo antispiralizzazione progettato per le piante da frutto.

Long pot non rooting-circling, designed for fruit plants.

Art.	Ø cm >	Ø cm <	Altezza cm Height cm	Litri Liter	Pcs. x Pallet
ERF 17	18	17	19	3,3	5040
ERF 18	19	18	23	4	2880
ERF 20	21,5	20	26,5	6	3000
ERF 24	26	24	29	10	1500

Colore disponibile su richiesta con maggiorazione di prezzo
Color available on demand, prices upon request

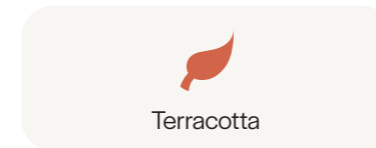

Varia

Vaso Antispiralizzazione in PE Rigenerato *Non Rooting - Circling Pot in Recycled Polyethylene*

Art.	Ø cm >	Ø cm <	Altezza cm Height cm	Litri Liter	Pcs. x Pallet
VA 110	65	60	51	110	160
VA 130	70	65	51	130	110
VA 180	78	73	53	180	sfusi loose
VA 285	95	90	55	285	sfusi loose
VA 375	102	93	65	375	sfusi loose



Scegli il vantaggio di coltivare in Ercole:

I risultati di una sperimentazione dell'Università di Pisa.

Nel corso del 2020, è stata condotta una breve sperimentazione dal Dipartimento di Scienze Agrarie Alimentari e Agroambientali (DiSAAA-a) dell'Università di Pisa, in collaborazione con un'importante azienda vivaistica di Pistoia, per testare l'efficacia del vaso ERCOLE rispetto all'utilizzo di vasi da vivaio classici, su differenti specie ornamentali.

L'esperimento è durato in totale 220 giorni. Tutte le specie sono state rinvasate con un substrato a base di fibra di cocco con diversa proporzione fra le dimensioni delle fibre per ottenere il giusto rapporto fra aria e acqua trattenuta. L'irrigazione è stata effettuata utilizzando un impianto di irrigazione a goccia. I risultati ottenuti da questa sperimentazione hanno dimostrato che il vaso ERCOLE induce a fine stagione vegetativa una maggiore sanità dell'apparato radicale su tutte le specie testate con una sola eccezione per la quale non sono state riscontrate differenze significative ma nemmeno peggiorative.

Va evidenziato, infatti, che il vaso ERCOLE non ha mai causato IN NESSUNA DELLE SPECIE TESTATE una riduzione della crescita delle piante. Con il Citrus Myrtifolia e il Citrus Japonica, in particolare, il vaso ERCOLE – grazie al miglior stato sanitario dell'apparato radicale – ha significativamente incrementato l'altezza delle piante e la dimensione in volume della parte aerea, vantaggio molto importante anche ai fini della commercializzazione. Il vaso ERCOLE ha aumentato l'area fogliare su tutte le specie di Citrus testate.

La funzionalità di ERCOLE ha mostrato visivamente gli effetti benefici sulla sanità dell'apparato radicale che, non solo controlla direttamente l'assorbimento di acqua e sostanze nutritive, ma produce anche importanti segnali ormonali che influenzano la crescita della parte aerea della pianta.



Take the advantages to growing into Ercole:

the results of a trial of the University of Pisa.

During 2020, a short experimentation was conducted by the Department of Agricultural, Food and Agri-environmental Sciences (DiSAAA-a) of the University of Pisa, in collaboration with an important nursery company in Pistoia, to test the effectiveness of the ERCOLE pots compared with the classical nursery pots on different ornamental species.

The experiment lasted a total of 220 days. All the species were repotted with a substrate based on coconut fiber with different proportions between the dimensions of the fibers to obtain the right ratio between air and retained water. Irrigation was carried out using a drip irrigation system. The results obtained from this test have shown that the ERCOLE pot, at the end of the growing season, induces greater health of the root system on all the species tested, with one exception, for which no significant but not even worse differences were found.

It should be noted, in fact, that the ERCOLE pot has never caused a reduction in plant growth IN ANY OF THE TESTED SPECIES. In particular, the ERCOLE pot, with Citrus Myrtifolia and Citrus Japonica, - thanks to the better sanitary state of the root system - has significantly increased the height of the plants and the volume size of the aerial part, a very important advantage also for the purpose of marketing.

The ERCOLE pot has increased the leaf area on all the Citrus species tested. The functionality of ERCOLE visually showed the beneficial effects on the health of the root system, that not only directly controls the absorption of water and nutrients but also produces important hormonal signals that influence the growth of the aerial part of the plant.

Settembre 2020 | September 2020



Novembre 2020 | November 2020



I nostri clienti:

Cosa dicono di ERCOLE.

“Dopo una tempesta, abbiamo ispezionato gli alberi caduti e abbiamo scoperto che le radici erano tutte spiralizzate e non si erano diramate anche se, quando gli alberi erano stati piantati, i paesaggisti avevano tagliato le radici esterne. Abbiamo capito che dovevamo cambiare il nostro modo di coltivare. Ci hanno suggerito un'azienda italiana che aveva vasi con fori laterali che forse avrebbero fatto al caso nostro. Ne abbiamo ordinati alcuni e abbiamo iniziato a usarli per gli abeti rossi. Non abbiamo provato solo i vasi Pasquini & Bini. Abbiamo anche testato vasi prodotti negli Stati Uniti e in Europa e persino provenienti dalla Cina. Abbiamo fatto prove per oltre due anni e alla fine eravamo assolutamente convinti che il vaso Ercole di Pasquini & Bini fosse l'unico che avremmo adoperato. Utilizzando questo vaso, abbiamo avuto la sopravvivenza delle piante. Il vaso anti-spiralizzazione Ercole ci ha dato la fiducia necessaria per far crescere alberi e sapere che sopravviveranno per molte generazioni a venire”.

Consigli per la coltivazione

È possibile migliorare i risultati con Ercole e Super-Ercole lavorando sul tipo di substrato. Infatti, un substrato compatto e drenante migliora lo sviluppo del sistema radicale ricreando, all'interno del vaso, una condizione simile a quella del pieno campo. Il miglior substrato da usare è dato da una miscela particolare composta da torba, fibra di cocco, midollo di cocco e un concime a cessione controllata. La fibra e il midollo di cocco garantiscono una ritenzione idrica maggiore e conferiscono una stabilità strutturale, aumentando la capacità di interscambio fra acqua e aria. Questi fattori dimostrano come una scelta oculata del substrato influisca in modo decisivo sul risultato finale, sia esso tecnico o commerciale, della coltivazione in Ercole e Super-Ercole.

Our customers:

What they say about ERCOLE.

“After the windstorm, we inspected the trees on the ground and found that the roots were all still circling. They had not broken out of the pattern of circling even though when planted the landscapers had cut the outside roots. I knew then that we had to change our growing practices.

We were recommended an Italian company that had pots with side holes and that maybe would work for us. We ordered some and started using them on spruce line. We didn't just try this suggestion. We also tried pots from USA and Europe and even China.

We tested for over two years and in the end, we were absolutely convinced that the Ercole pot was the only one we would use. By using this pot, we have aided the survivability of the plants. The Ercole air pruned pot has given us the confidence to grow trees and know that they will survive for many generations to come.”







Cultivation tips

It is possible to improve the result with Ercole and Super-Ercole pots, working on the kind of substrate. A compact and draining substrate improves indeed the development and the rooting system because inside the pot a situation similar to that of an open field is reproduced.

The best substrate to be used is given by a particular mix of peat, coco fiber, coco pith and a controlled release fertilizer. The coco fiber allows a major water retention and gives to the substrate a structural stability, increasing the capacity of mutual exchange between water and air.

All these factors demonstrate how a wise choice of the substrate effects the results in a remarkable way, both technical and commercial, of the growing into Ercole and Super-Ercole pots.



-  SVILUPPA PIÙ VELOCEMENTE L'APPARATO RADICALE
DEVELOP THE ROOT SYSTEM IN A QUICKER WAY
-  MIGLIORA IL DRENAGGIO
IMPROVE THE DRAINAGE
-  MANTIENE PIÙ SANO L'APPARATO RADICALE
KEEP THE ROOT SYSTEM HEALTHY
-  SVOLGE UN'AZIONE ANTISPIRALIZZAZIONE
ANTI-ROOTING ACTION
-  MIGLIORA IL PROCESSO DI CRESCITA DELLE PIANTE
IMPROVE THE GROWTH OF THE PLANTS
-  ANNULLA LO STRESS DA TRAPIANTO
REDUCE THE STRESS CAUSED BY THE TRANSPLANTATION

Ercole

Vaso Antispiralizzazione in PE Rigenerato

Non Rooting - Circling Pot in Recycled Polyethylene

Le piante prodotte nei vasi Ercole non solo riducono notevolmente il tempo di accrescimento ma, una volta messe a dimora, garantiscono una presa sicura e una crescita immediata. Grazie al suo sviluppato sistema di aerazione (dato dai fori laterali) una volta che le radici entrano in contatto con l'aria e con la luce, bloccano il loro andamento circolare. In questo modo l'apparato radicale periferico della pianta non va in stress e la crescita del fusto è più veloce e vigorosa che nei normali vasi da vivaio.

Once bedded out, plants grown in Ercole pots, not only reduce considerably the growing time, but grants a sure taking of the roots and an immediate growth. Thanks to its developed air-system (given by the side holes), once the roots get in touch with the air and light, they stop their circular pattern. In this way, the side root system does not stress and the growth of the stem is faster and more vigorous than in a standard pot.

Art.	Ø cm >	Ø cm <	Altezza cm Height cm	Ø utile cm Usable cm	Litri Liter	Pcs. x Pallet
SP 14	14	13	16	10	1,3	2400*
SP 16	16,5	15	14,5	13	2	4320
SP 19	19	18	17,5	15	3	2880
SP 23	23	21	20	17	5	2000
SP 26	26	24	22	20	7,5	1100
SP 28	28,5	26,5	24	21,5	9,5	960
SP 30	30,5	28	26,5	22,5	12	600
SP 33	33	30,5	29	26	20	630
SP 37	37,5	34,5	32	29	25	720
SP 42	42	38	36	32	35	450
SP 50	50	46	39	38	50	220
SP 55	55	50	45	41	70	140
SP 60	60	57	46	45	90	140

*Pcs. x Palletbox



Super Ercole

Vaso Antispiralizzazione in PE Rigenerato

Non Rooting - Circling Pot in Recycled Polyethylene

In seguito al grande successo riscosso dal vaso Ercole e grazie alla collaborazione dei nostri maggiori clienti, abbiamo incrementato ulteriormente la potenzialità di questo tipo di vaso con un nuovo e rivoluzionario fondo a rete.

Con questo nuovo sistema le radici, già indirizzate verso il suolo grazie alla struttura del vaso Ercole, hanno una grande ossigenazione e il risultato è quello di una pianta più sana e robusta. Inoltre, i fori presenti sulla parte bassa del bordo (non presenti nel vaso Ercole) impediscono la spiralizzazione delle radici anche nella parte superiore del vaso.

After the great success of Ercole pot and thanks to the cooperation of our major customers, we have further increased the potentiality of this kind of pot with a new and revolutionary net-bottom.

With such new system the roots, already directed toward the ground thanks to the structure of the Ercole pot, have a great oxygenation and the result is a healthier and stronger plant. Moreover, the holes on the lower rim (that are not present on the Ercole pot) prevent the roots' spiralization also on the upper part of the plant.

Art.	Ø cm >	Ø cm <	Altezza cm Height cm	Ø utile cm Usable cm	Altezza utile cm Height usable cm	Litri Liter	Pcs. x Pallet
SSP 21	21,5	19	19	16	16	3,5	1750
SSP 30	30,5	28	26,5	22,5	23	12	600
SSP 37	37,5	34,5	32	29	29	25	600
SSP 45	45	42	38	34	33	45	210



Super Ercole Quadro | *Super Ercole Square Pot*

Vaso Antispiralizzazione in PP Rigenerato
Non Rooting - Circling Pot in Recycled Polypropylene



Con lo stesso concetto del vaso Super Ercole, nasce il Super Ercole Quadro. Il fondo, particolarmente innovativo, presenta una rientranza a forma di tronco di cono che, attraverso numerose aperture, permette una migliore ossigenazione dell'apparato radicale, nonché un eccellente drenaggio.

From the same concept of the SUPER ERCOLE pot, derives the new SQUARE SUPER ERCOLE pot. The particularly innovative bottom has an inner recess with the shape of a truncated cone that, thanks to many holes, allows a better oxygenation of the roots' system, further than a very good drainage.

Art.	Lungh. cm Lenght cm	Largh. cm Width cm	Altezza cm Height cm	Litri Liter	Pcs. x Pallet
SPQ 20	20	20	25,5	6,5	2400
SPQ 23	23	23	28	9	1400



Ercole Cassetta *Ercole Rectangular Growing Box*

in Polietilene Rigenerato | in Recycled Polyethylene

L'esigenza di una nuova cassetta per coltivare le piante è sempre stata sentita dalla clientela. Questo è il modo migliore per far crescere le piante robuste e sane. Quando viene il momento della vendita, la CASSETTA ERCOLE è precisa per entrare in una cassetta multicolore che darà maggior risalto alle piante prodotte.

The production of a new Rectangular Box to grow plants is a need always been felt by customers. This is the best way to grow strong and healthy plants. When the time of sale comes, the ERCOLE BOX is suitable to fit in a multicolor Flower box in order to give greater emphasis to the plants produced.

Art.	Lungh. cm Lenght cm	Largh. cm Width cm	Altezza cm Height cm	Litri Liter	Pcs. x Pallet
SPC 70	69	28,5	28,5	45	480



Vedi cassetta Carina | See Carina flower-box: pag.142



Miss pot

Vaso in Polipropilene Copolimero | Copolymer Polypropylene pot

Dalle esperienze con il vaso Ercole e Super-Ercole nasce "Miss", un'idea innovativa del vaso antispiralizzazione particolarmente indicato per la coltivazione delle piante da frutto. **Per una crescita sana e rapida dell'apparato radicale.**

"MISS" comes from the experience with Ercole and Super Ercole pots, an innovative idea of the non rooting-circling pot, ideal for the cultivation of fruit plants. For a healthy and fast growth of the roots' system.

Art.	Ø cm >	Ø cm <	Altezza cm Height cm	Litri Liter	Pcs. x Pallet
MISS 18	19	18	17	3	3300



Super Vega

Vaso in Polipropilene Copolimero | Pot in Copolymer Polypropylene

L'habitat più "naturale" dove coltivare le tue piante

Dall'enorme successo del vaso VEGA, nasce il SUPER VEGA, dove il continuo scambio di acqua, ossigeno e luce ricrea l'habitat più naturale dove coltivare le tue piante.

Le costolature presenti in questo vaso favoriscono la corretta radicazione dall'alto verso il basso. Il fondo, particolarmente innovativo, presenta una rientranza a forma di tronco di cono che, attraverso numerose aperture, permette una migliore ossigenazione dell'apparato radicale, nonché un eccellente drenaggio. Tali risultati sono amplificati anche dai fori presenti alla base di ogni costolatura. La realizzazione di questo tipo di fondo è importante anche perché permette la penetrazione della luce.

The most "natural" habitat where growing your plants

From the big success of the VEGA pot, we have developed the SUPER VEGA pot, where the continuous exchange of water, oxygen and light re-create the most natural "habitat" where growing your plants. The vertical ribs promote right root growth from the top to bottom.

The particularly innovative bottom has a inner recess with the shape of a truncated cone that, thanks to many holes, allows a better oxygenation of the roots' system, further than a very good drainage. Such results are amplified also by the holes at the end of each rib. The particular shape of this bottom is important also because allows the insight of the light.

Art.	Lungh. cm Length cm	Largh. cm Width cm	Altezza cm Height cm	Litri Liter	Pcs. x Pallet
SUVE 9N	25	25	25,5	9	2000
SUVE 16N	30,5	30,5	30,5	16	1080





GEA – linea vasi prodotti con bioplastica compostabile

Da una collaborazione stretta con il Dipartimento di Ingegneria Civile ed Industriale dell'Università degli Studi di Pisa che ha messo a frutto, con lo stampaggio dei vasi, l'esperienza e competenza nella ricerca e sviluppo dell'ingegneria dei materiali, è nata la Linea GEA, una serie di prodotti Pasquini e Bini ideati per una valida alternativa - "green" ed "eco-sostenibile" - ai materiali realizzati con la plastica tradizionale, derivata da petrolio e non biodegradabile.

I vasi Pasquini e Bini GEA sono prodotti con compound biocompositi, ad alto contenuto di materiali biobased e provenienti da fonti rinnovabili; sono concepiti per essere stampati con materiali completamente biodegradabili e compostabili in compost industriale. È possibile anche produrli con compound compostabile in terreno e in ambiente marino.

**PER MAGGIORI INFORMAZIONI
E PER RICHIEDERE CAMPIONI**
info@pasquiniibini.it

GEA – pots line produced with bioplastic compounds

From a close collaboration with the Department of Civil and Industrial Engineering of the University of Pisa that has made use of the experience and expertise in research and development of materials engineering, is born our new product **GEA**, a series of Pasquini & Bini products designed as a valid alternative - "green" and "eco-sustainable" - to products made with traditional plastic, derived from petroleum and non-biodegradable.

The Pasquini & Bini pots GEA are produced with biocomposite compounds, based on a high content of biobased materials and coming from renewable sources. They are designed to be produced with completely biodegradable and compostable materials in industrial compost. It is also possible to produce them with a compound that is compostable in soil and in a marine environment.

**FOR MORE INFORMATION
AND REQUIRE FREE SAMPLES**
info@pasquiniibini.it

PB-PLA e PB-PLAFL

Il PB-PLA e il PB-PLAFL sono compound biocompositi costituiti da materiali polimerici derivanti da risorse rinnovabili, quali biomasse, in miscela anche con fibre vegetali ligno-cellulosiche (PB-PLAFL). La loro natura li rende pertanto eco-sostenibili, a basso impatto ambientale, permettendo tramite la produzione da biomassa di bilanciare le emissioni di anidride carbonica.

Sono completamente biodegradabili e compostabili in compostaggio industriale.

Il mercato dei compound bioplastici è nuovo; per questo la disponibilità delle materie prime potrebbe non essere garantita. Anche i prezzi sono soggetti a continue oscillazioni. Per questo motivo le quotazioni verranno effettuate su richiesta.

PB-PLA and PB-PLAFL

The PB-PLA and the PB-PLAFL are biocomposite compounds consisting of polymeric materials deriving from renewable resources, such as biomass, also mixed with ligno-cellulosic plant fibers (PB-PLAFL). Their nature therefore makes them eco-sustainable, with low environmental impact, allowing them to balance carbon dioxide emissions through biomass production.

They are completely biodegradable and compostable in industrial composting.

The market of bioplastic compounds is quite new; that's why the availability of the raw materials could be not guaranteed. Also price are subject to continuous fluctuatinos. For this reasons, quotations will be made on request.

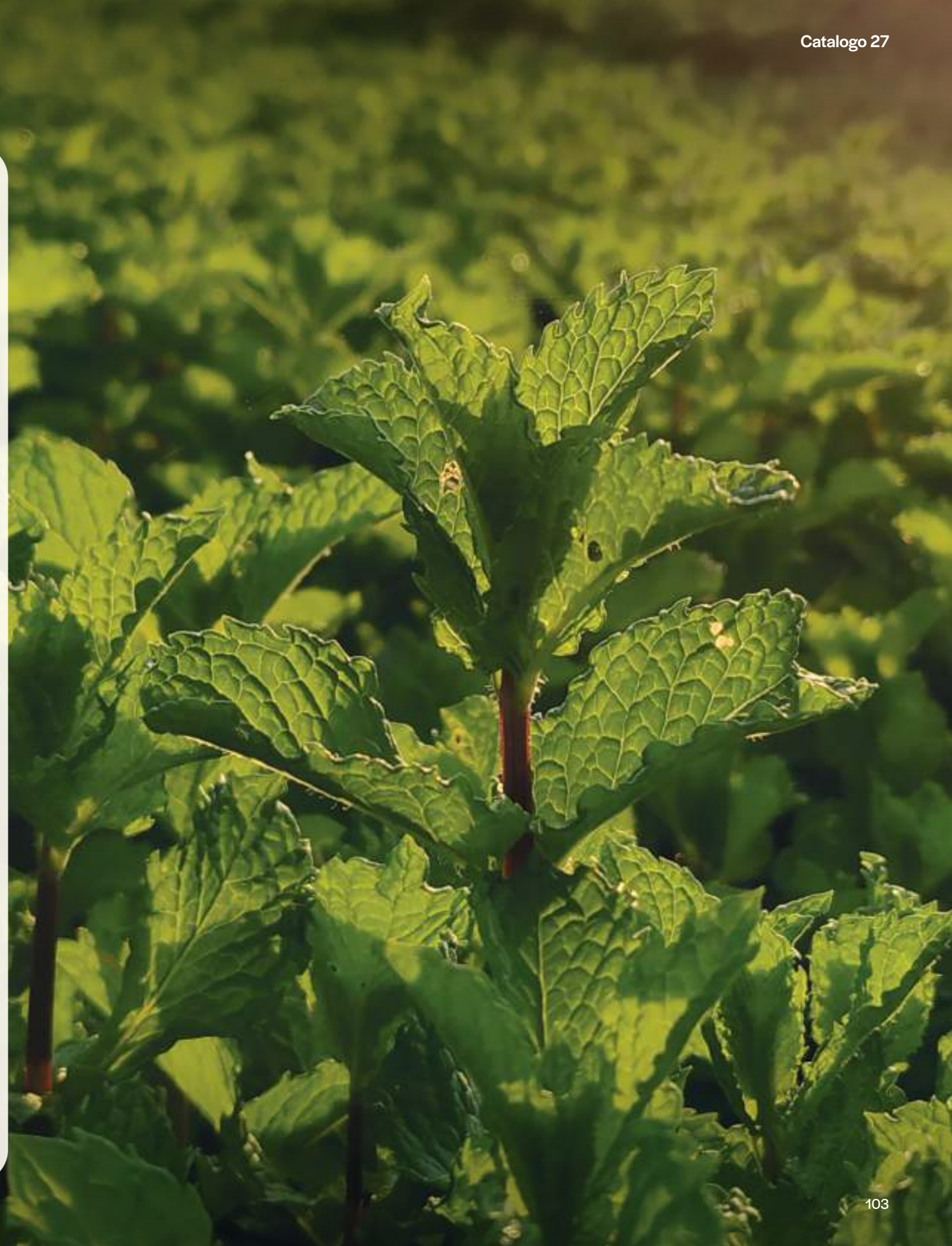



Fenice Terracotta

FORI SOTTO | *BOTTOM HOLES*

Art.	Ø cm >	Ø cm <	Altezza cm Height cm	Litri Liter	Pcs. x Pallet
FE 19TC	19,2	17,5	16,5	3	4200
FE 21TC	21,5	19,5	18,5	4,5	3000
FE 23TC	23,5	21,5	20,5	6	1600
FE 25TC	25,5	23,5	22,5	7,5	1400
FE 26TC	26,5	24	23,5	9	1400
FE 28TC	28	26	24,5	10	1360
FE 30TC	30,5	28	26,5	12,5	1360
FE 32TC	32	29	27	15	840
FE 34TC	34	31	28,5	18	780
FE 35TC	35,5	32,5	30,5	20	630
FE 37TC	37,5	34,5	32	25	540
FE 40TC	40,5	37	33,5	30	450
FE 44TC	44	40	35	35	440
FE 47TC	47	43	37,5	45	250
FE 50TC	50,5	46	40	55	250



Fenice Terracotta

FORI SOTTO E LATERALI | *BOTTOM AND SIDE HOLES*

Art.	Ø cm >	Ø cm <	Altezza cm Height cm	Litri Liter	Pcs. x Pallet
FE 56TC	56	51	43	70	180
FE 60TC	60	55	47	90	200
FE 66TC	66	61	48	110	140
FE 69TC	69	64	50	130	105
FE 75TC	75	69	52	150	sfusi loose
FE 78TC	78	73	53	180	sfusi loose
FE 85TC	85	80	56	230	sfusi loose



Sottovaso | *Saucer*

Art.	Ø cm >	Pcs. x Box	Pcs. x Pallet
SF 18 TC (FE19 - FE21)	18	110	8800
SF 20 TC (FE23)	20	120	5040
SF 25 TC (FE25-FE28-FE30)	25	90	3240
SF 30 TC (FE32-FE34-FE 35-FE37)	30	60	1800
SF 35 TC (FE40-FE44)	35	50	1500
SF 40 TC (FE47-FE50)	40	25	1050
SF 45 TC (FE56)	45	25	700
SF 50 TC (FE60)	50	25	450



Fenice Nero | *Fenice Black*

FORI SOTTO | *BOTTOM HOLES*

Art.	Ø cm >	Ø cm <	Altezza cm Height cm	Litri Liter	Pcs. x Pallet
FE 19N	19,2	17,5	16,5	3	4200
FE 21N	21,5	19,5	18,5	4,5	3000
FE 23N	23,5	21,5	20,5	6	1800
FE 25N	25,5	23,5	22,5	7,5	1400
FE 26N	26,5	24	23,5	9	1600
FE 28N	28	26	24,5	10	1440
FE 30N	30,5	28	26,5	12,5	1440
FE 32N	32	29	27	15	1000
FE 34N	34	31	28,5	18	960
FE 35N	35,5	32,5	30,5	20	720
FE 37N	37,5	34,5	32	25	630
FE 40N	40,5	37	33,5	30	600
FE 44N	44	40	35	35	520
FE 47N	47	43	37,5	45	300
FE 50N	50,5	46	40	55	275



Fenice Nero | *Fenice Black*

FORI SOTTO E LATERALI | *BOTTOM AND SIDE HOLES*

Art.	Ø cm >	Ø cm <	Altezza cm Height cm	Litri Liter	Pcs. x Pallet
FE 56N	56	51	43	70	220
FE 60N	60	55	47	90	200
FE 66N	66	61	48	110	160
FE 69N	69	64	50	130	120
FE 75N	75	69	52	150	sfusi loose
FE 78N	78	73	53	180	sfusi loose
FE 85N	85	80	56	230	sfusi loose
FE 95N	95	85	57	290	sfusi loose
FE 120N	120	110	65	500	sfusi loose

FE 120N



FE 56N



Sottovaso Nero | *Black Saucer*

Art.	Ø cm >	Pcs. x box	Pcs. x Pallet
SF18N (FE19-FE21)	18	110	8800
SF20N (FE23)	20	120	5040
SF25N (FE25-FE28-FE30)	25	90	3240
SF30N (FE32-FE34-FE35-FE37)	30	60	1800
SF35N (FE40-FE44)	35	50	1500
SF40N (FE47-FE50)	40	25	1050
SF45N (FE56)	45	25	700
SF50N (FE60)	50	25	450



Vaso Nero Tondo Vivaio Black Round Nursery Pot

Vaso da vivaio in polietilene rigenerato (PE) estremamente resistente agli sbalzi di temperatura e estremamente flessibile. Fori di drenaggio laterali e/o sul fondo.

Growing nursery pots in recycled polyethylene (PE), extremely resistant to the rise/fall in temperature and extremely flexible. Side and/or bottom holes.

Art.	Ø cm <	Altezza cm Height cm	Litri Liter	Pcs. x Pallet
A 16 C	16	16	2,8	6300
A 16	16	16	3	4200/4950/5200
A 18	18	18	4	4200/3780
A 20	20	20	5	2250/2700
A 22	22	22	7	1800/2000
A 24	24	24	9,5	1800/2000
A 26	26	26	12	1600/1800/2000
A 28	28	28	15	1120/1200/1520
A 30	30	30	18,5	1120/1080
A 33	33	33	25	765/810
A 35	35	37	30	540

Colore disponibile su richiesta con maggiorazione di prezzo
Color available on request with price increase

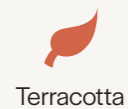

Terracotta



Vaso Nero Serie Bassa Black Round Low Range

Vaso basso da vivaio, realizzato con polietilene riciclato post-consumo, resistente agli sbalzi di temperatura ed estremamente flessibile.

Low nursery pot, made from post consumer polyethylene, resistant to temperature changes and extremely flexible.

Art.	Ø cm <	Altezza cm Height cm	Litri Liter	Pcs. x Pallet
B 15	15	14	2	8400
B 18	18	16	3,3	4200/4680
B 18 G	18	16	3,6	4200
B 20	20	16	4,3	2500
B 22	22	18	5	2500
B 24	24	20	7,5	1800/2500
B 26	26	22	10	1600/2000
B 28	28	24	12	1440/1600
B 30	30	26	15	1080
B 32	32	26	20	1020
B 35	35	28	25	810/855
B 40	40	31	35	450
B 42	42	32	40	450

Colore disponibile su richiesta con maggiorazione di prezzo
Color available on request with price increase



Terracotta



Mastelli con Manici

Heavy Duty Containers with handles

in Polietilene Rigenerato nero (PE) | in Recycled Polyethylene (PE)

Art.	Ø >	Ø <	Altezza cm Height cm	Litri Liter	Pcs. x Pallet
MM 40	40	37	33	30	720
MM 45	45	40	37	35	560
MM 50	50	45	34	43	400
MM 50/A	50	45	41	50	350
MM 55/BB	55	50	38	60	300
MM 55/B	55	50	41	65	300
MM 55	55	50	44	70	260
MM 55/A	55	50	48	75	280
MM 60/B	60	55	43	80	240
MM 60	60	55	48	90	240
MM 60/A	60	55	51	100	240
MM 65/BB	65	60	40	90	220
MM 65/B	65	60	44	100	180
MM 65	65	60	51	110	180
MM 65/A	65	60	54	125	150
MM 70	70	65	51	130	150
MM 75	75	70	51	155	sfusi loose
MM 80	80	75	51	160	sfusi loose



Mastelli Senza Manici

Heavy Duty Containers without handles

Gamma completa di Mastelli senza manici in polietilene rigenerato (PE), adatta per ogni tipo di pianta, anche di grosse dimensioni.

Complete range of Potting Tubes in recycled polyethylene (PE), without handles, ideal for any kind of plants, even of big dimensions.

Art.	Ø >	Ø <	Altezza cm Height cm	Litri Liter	Pcs. x Pallet
R 70/BB	70	65	46	120	120
R 70/B	70	65	55	140	120
R 70	70	65	59	150	sfusi loose
R 75	75	68	60	200	sfusi loose
R 80/B	80	75	51	160	sfusi loose
R 80	80	75	55	210	sfusi loose
R 80/A	80	75	65	240	sfusi loose
R 85	85	80	55	230	sfusi loose
R 95	95	90	55	285	sfusi loose
R 88	88	83	69	300	sfusi loose
R 95/A	95	90	73	350	sfusi loose
R 102	102	94	82	500	sfusi loose
R 102/B	102	93	65	375	sfusi loose
R 110	110	100	68	450	sfusi loose
R 115	115	105	71	525	sfusi loose
R 120	120	110	68	600	sfusi loose
R 120/A	120	110	78	750	sfusi loose
R 140	140	130	90	1000	sfusi loose
R 155	155	145	100	1500	sfusi loose



R 80/A

R 120

Mastelli con Manici laterali sotto Heavy Duty Containers with below handles

Mastelli in polietilene rigenerato (PE) con manici laterali sotto, ideale per palme e agrumi.
Potting Tubes in recycled polyethylene (PE), with side handles below, ideal for palms and citrus trees.

Art.	Ø cm >	Ø cm <	Altezza cm Height cm	Litri Liter	Pcs. x Pallet
ML 30	39	35	37	30	540
ML 40	44	40	42	45	280
ML 45	47	45	47	65	150



ML 30

ML 40 - ML 45

Mastelli con manici laterali terracotta Heavy Duty Containers Terracotta with handles

Art.	Ø cm >	Ø cm <	Altezza cm Height cm	Litri Liter	Pcs. x Pallet
MM 40 TC	40	37	33	30	720
MM 45 TC	45	40	37	35	560
MM50/A TC	50	45	41	50	350



Mastelloni bassi senza fori Heavy Duty Squat Containers without holes

Mastellone basso in polietilene rigenerato (PE) senza fori, ideale per la cultura di piante acquatiche.
Squat low potting tubes in recycled polyethylene (PE), without holes, ideal for the cultivation of aquatic plants.

Art.	Ø cm >	Ø cm <	Altezza cm Height cm	Litri Liter	Pcs. x Pallet
RB 88	88	80	32	150	sfusi loose
RB 96	96	89	43	240	sfusi loose
RB 110	110	102	35	275	sfusi loose



Mastelli con manici rinforzati Heavy Duty Containers with reinforced handles

Art.	Ø cm >	Ø cm <	Altezza cm Height cm	Litri Liter	Pcs. x Pallet
VR 40	43	40	28	30	300
VR 45	50	45	34	48	300
VR 50	54	50	35	60	220





“Ogni luogo può essere quello giusto”

Con la coltivazione in contenitore, il mirtillo può crescere ovunque. La coltivazione in vaso, di qualsiasi varietà, garantisce una maggiore resa produttiva. Scegliere il vaso giusto può fare la differenza: con un substrato studiato per questa pianta a base di torba acida, fibra di cocco e perlite, la struttura del suolo sottostante non è più un problema ed è possibile realizzare un impianto produttivo in qualsiasi luogo, garantendo alla pianta, allo stesso tempo, il terreno migliore.





“Everywhere can be the right place”

Blueberries can be grown everywhere with container cultivation. Growing any variety of blueberries in pots guarantees a significant increase in production yield. The choice of the pot can make the difference. With an optimal mix of acidic soil, coco fibre and perlite the soil structure is no more a problem and it is possible to set up a production facility everywhere and guarantee at the same time the best soil.

La coltivazione in vaso consente un uso limitato dell'acqua (circa 1/10 rispetto alla produzione in suolo).

Grazie alla coltivazione in vaso e' possibile avere:

The pot cultivation allows a reduced quantity of water, ca. 1/10 part of the consumption of the growing in soil. **Thanks to pot cultivation you can have:**

- 
UN CONTROLLO COSTANTE DEL PH
PH CONTROL
- 
UNA CRESCITA DELL' APPARATO RADICALE PIÙ SANA E FORTE CON MAGGIORE RESA PRODUTTIVA
HEALTHIER AND STRONGER ROOT SYSTEM GROWTH WITH GREATER YIELD
- 
IL CONTROLLO DELL' UMIDITÀ
HUMIDITY AND STAGNATION CONTROL
- 
IL CONTROLLO SULL'UTILIZZO DEI FERTILIZZANTI E DEI NUTRIENTI
FERTILIZERS AND NUTRIENTS CONTROL
- 
MINORE IMPATTO AMBIENTALE CON RIDOTTO IMPIEGO DI PRODOTTI CHIMICI
LESS ENVIRONMENTAL IMPACT FOR A REDUCED USE OF CHEMICAL PRODUCTS

I vasi Pasquini&Bini, realizzati in materiale riciclato post consumo e garantiti per una lunga durata nel tempo, sono la giusta soluzione **per la produzione di mirtilli.**

The Pasquini & Bini pots are made of post-consumer plastic and guaranteed for a long life. They are the right solution **for blueberries cultivation.**



LA DISTANZA DAL SUOLO È DI 4cm
DISTANCE FROM THE GROUND UP TO 4cm



ERACLE



SUPER ERACLE



ERCOLE



SUPER ERCOLE



MASTELLI CON MANICO RINFORZATO
HEAVY DUTY CONTAINERS WITH REINFORCED HANDLES



MASTELLI CON MANICI
HEAVY DUTY CONTAINERS WITH HANDLES



VASO QUADRATO NERO ANTISPIRALIZZAZIONE
BLACK SQUARE POT WITH ANTI-ROOTING GROVES



Maggiori informazioni sull'utilizzo dei nostri vasi per le coltivazioni dei mirtili.
More information about the use of pot to grow blueberries.

Perseo

Vaso prodotto in polietilene alta densità (PEHD), stabilizzato ai raggi UV, adatto alla coltivazione fuori campo.
Pot manufactured in high density polyethylene (PEHD), stabilized to the UV rays, right for the open field cultivation.

Art.	Ø cm >	Altezza cm Height cm	Litri Liter	Pcs. x Pallet
N13	13	13	1,5	6720
N18	18	18	4	2250
N20	20	20	5	2250
N22	22	22	7	1800
N24	24	24	9,5	1800
N26	26	26	12	960
N28	28	28	15	720
N30	30	30	18,5	720
N33	33	33	25	450
N36	36	36	30	450
N40	40	40	42	300
N50	50	41,5	65	200

Sottovaso | Saucer

Art.	Ø cm >	Pcs. x Box
SK 18 (N18)	18	110
SK 20 (N20-N22)	20	120
NK 24 (N24)	24	90
SK 25 (N26-N28)	25	90
SK 30 (N30-N33)	30	60
SK 35 (N36)	35	50
SK 40 (N40)	40	25
SK 50 (N50)	50	25



PERSEO



SOTTOVASO SAUCER

Cigno

Vaso basso prodotto in polietilene ad alta densità (PEHD), stabilizzato ai raggi UV. Per la floricoltura e il vivaismo.
Low pot manufactured in high density polyethylene (PEHD), stabilized to the UV rays. For floriculture and nursery.

Art.	Ø cm >	Altezza cm Height cm	Litri Liter	Pcs. x Pallet
K 16	15,5	13,5	2	4200
K 20	20	16	4,3	1800
K 22	22	18	5	1800
K 24	24	20	7,5	1800
K 26	26	22	10	1200
K 28	28	24	12	1020
K 30	30	26	15	720
K 33	33	29	22	630
K 36	36	31	25	540
K 40	40	35	35	300
K 45	45	36	50	200
K 50	50	37	63	180
K 55	55	44	80	160
K 60	60	48	115	60

Sottovaso | Saucer

Art.	Ø cm >	Pcs. x Pallet
SK 20 (K20)	20	120
NK 24 (K24)	24	90
SK 25 (K26)	25	90
SK 30 (K28-K30)	30	60
SK 35 (K33-K36)	35	50
SK 40 (K40)	40	25
SK 45 (K45)	45	25
SK 50 (K50)	50	25



CIGNO



SOTTOVASO SAUCER

PERSEO



Vega Terracotta

Vaso in Similcotto in Polipropilene Copolimero Pot Similcotto in Copolymer Polypropylene

Questo vaso in polipropilene copolimero stabilizzato contro i raggi UV, si contraddistingue nella varietà dei vasi da produzione per la sua nuova linea quadrata, pur mantenendone tutte le caratteristiche.

This pot in copolymer polypropylene stabilized for the UV rays, stands out for its new square shape among the variety of growing pots, but maintaining all the features.

Art.	Lato Est Int cm Side out Ins cm	Lato Est Int cm Side out Ins cm	Altezza cm Height cm	Litri Liter	Pcs. x Pallet
VE 13 TC	14,2/13	14,2/13	14,5	2	1720*
VE 17 TC	19/17,2	19/17,2	19,2	5	3300
VE 19 TC	21/19,2	21/19,2	21,6	6	3600
VE 21 TC	23/21,2	23/21,2	24	9	3000
VE 23 TC	25/23	25/23	25,5	11	2000
VE 25 TC	28,5/25	28,5/25	28,4	14	1600
VE 27 TC	30,5/27,5	30,5/27,5	30,5	18	1200
VE 30 TC	33,5/30	33,5/30	33,5	25	540
VE 33 TC	36,5/32,5	36,5/32,5	36	30	675

*Pcs. x Palletbox

Colori disponibili per quantità | Available colors for quantity



Sottovaso | Saucer

Art.	Lato Est Int cm Side out Ins cm	Lato Est Int cm Side out Ins cm	Pcs. x Box	Pcs. x Pallet
SV13TC (VE13-LT.2)	14,1/12,5	14,1/12,5	100	11200
SV17TC (VE17-LT.5)	18,9/16,5	18,9/16,5	120	9600
SV19TC (VE19-LT.6)	21/18	21/18	160	7840
SV21TC (VE21-LT.9)	23/20	23/20	150	7350
SV23TC (VE23-LT.11)	25/22	25/22	200	6000
SV25TC (VE25-LT.14)	28,5/25,4	28,5/25,4	150	4500
SV27TC (VE27-LT.18)	30,5/27,2	30,5/27,2	130	3120
SV30TC (VE30-LT.25)	33,5/29,7	33,5/29,7	115	2760
SV33TC (VE33-LT.30)	36,5/32,5	36,5/32,5	60	2520

Colori disponibili per quantità | Available colors for quantity



Vega Black



Vaso in Polipropilene Copolimero | Black Pot in Copolymer Polypropylene

Art.	Lato Est Int cm Side out Ins cm	Lato Est Int cm Side out Ins cm	Altezza cm Height cm	Litri Liter	Pcs. x Pallet
VE 13 N	14,2/13	14,2/13	14,5	2	1720*
VE 17 N	19/17,2	19/17,2	19,2	5	3300
VE 19 N	21/19,2	21/19,2	21,6	6	3600
VE 21 N	23/21,2	23/21,2	24	9	3000
VE 23 N	25/23	25/23	25,5	11	2000
VE 25 N	28,5/25	28,5/25	28,4	14	1600
VE 27 N	30,5/27,5	30,5/27,5	30,5	18	1200
VE 30 N	33,5/30	33,5/30	33,5	25	540
VE 33 N	36,5/32,5	36,5/32,5	36	30	675

*Pcs. x Palletbox

Sottovaso | Saucer

Art.	Lato Est Int cm Side out Ins cm	Lato Est Int cm Side out Ins cm	Pcs. x Box	Pcs. x Pallet
SV13N (VE13-LT.2)	14,1/12,5	14,1/12,5	100	11200
SV17N (VE17-LT.5)	18,9/16,5	18,9/16,5	120	9600
SV19N (VE19-LT.6)	21/18	21/18	160	7840
SV21N (VE21-LT.9)	23/20	23/20	150	7350
SV23N (VE23-LT.11)	25/22	25/22	200	6000
SV25N (VE25-LT.14)	28,5/25,4	28,5/25,4	150	4500
SV27N (VE27-LT.18)	30,5/27,2	30,5/27,2	130	3120
SV30N (VE30-LT.25)	33,5/29,7	33,5/29,7	115	2760
SV33N (VE33-LT.30)	36,5/32,5	36,5/32,5	60	2520



SOTTOVASO | SAUCER



VEGA NERO | BLACK

Vaso Serra per Vega e Vaso Quadrato Mini Greenhouse for Vega and Square Pot

La speciale valvola posta sull'apice serve a regolare e mantenere il tasso di umidità all'interno della "serra" artificiale. Può essere utilizzato con Q22 e VE23.

The special valve on the top of the pot regulates and maintains the rate of humidity inside the artificial "greenhouse". Can be used with Q22 and VE23

Art.	Lungh. cm Length cm	Largh. cm Width cm	Altezza cm Height cm	Pcs. x Pallet
SERRA	22	22	26	2000



VASO QUADRATO | SQUARE POT (Q22)
+ SERRA



VEGA + SERRA



Vaso Quadrato | Square Pot

Art.	Lungh. cm* Lenght cm*	Largh. cm* Width cm*	Altezza cm Height cm	Litri Liter	Pcs. x Pallet
(PP) Q10 Nero/Black	10	10	17	1,4	10000
(PP) Q11 Nero/Black	10,5	10,5	22	1,8	**2240
(PP) Q11 Colorato/Color	10,5	10,5	22	1,8	**2240
(PP) Q12 Nero/Black	12	12	13	1,7	8640
(PE) Q13 Nero/Black	13	13	18	2,4	5120/6000
(PE) Q15 Nero/Black	15	15	20	3,4	4500
(PP) Q18B Nero/Black	18	18	23	6	3000
(PP) Q18 Nero/Black	17,5	17,5	25	6,2	3000
(PP) Q18 Colorato/Color	17,5	17,5	25	6,2	3000
(PP) Q22 Nero/Black	22	22	26	11	2000
(PP) Q22 Colorato/Color	22	22	26	11	2000

*misura interna
*internal sizes

*misura interna
*internal sizes

**Pcs. x Palletbox

Colore disponibile solo per Q22
Color available only for Q22



Bianco
White

Vaso Quadrato con scanalature antispiralizzazione Square Pot with anti rooting grooves

Art.	Lungh. cm* Lenght cm*	Largh. cm* Width cm*	Altezza cm Height cm	Litri Liter	Pcs. x Pallet
Q13PP Nero/Black	13	13	20	2,6	5600
Q13PP Colorato/Color	13	13	20	2,6	5600
Q15PP Nero/Black	15	15	20	3,4	5250
Q15PP Colorato/Color	15	15	20	3,4	5250
Q18PP Nero/Black	18	18	23	5,8	3000
Q18PP Colorato/Color	18	18	23	5,8	3000

*misura interna
*internal sizes

*misura interna
*internal sizes

VASO QUADRATO | SQUARE POT



VASO QUADRATO ANTISPIRALIZZAZIONE SQUARE POT WITH ANTI ROOTING GROOVES



Orsa

Vaso in polipropilene copolimero dalla forma tondo-quadra per la coltivazione delle rose.
 Pot in copolymer polypropylene with a round-square shape ideal for the cultivation of roses.

Art.	Lungh. cm Lenght cm	Largh. cm Width cm	Altezza cm Height cm	Litri Liter	Pcs. x Pallet
QT 14 Nero/Black	14	14	14	2	*2680
QT 14 Colorato/Color	14	14	14	2	*2680
QT 16 Nero/Black	16	16	16	3	3920
QT 16 Colorato/Color	16	16	16	3	3920
QT 17 Nero/Black	18	18	18	4,5	3300
QT 17 Colorato/Color	18	18	18	4,5	3300

*Pcs. x Palletbox



QT 14 - QT 16 - QT 17 bordo ottagonale
 QT 14 - QT 16 - QT 17 octagonal rim



Art.	Lungh. cm Lenght cm	Largh. cm Width cm	Altezza cm Height cm	Litri Liter	Pcs. x Pallet
QT 14B Nero/Black	14	14	14,5	2	*2000
QT 14A Nero/Black	14	14	21	3	3430
QT 14A Colorato/Color	14	14	21	3	3430
QT 18 Nero/Black	18	18	24	6	3360
QT 18 Colorato/Color	18	18	24	6	3360
QT 22 Nero/Black	22	22	27	11	1600
QT 22 Colorato/Color	22	22	27	11	1600
QT 26 Nero/Black	26	26	32	15	1200
QT 26 Colorato/Color	26	26	32	15	1200

*Pcs. x Palletbox

Colori disponibili
 Available colors



Colori disponibili su richiesta per quantità
 Available colors on demand for quantity



Con porta etichette
 With Label Holder



Vaso Rose | *Roses Pot*

Vaso serie lunga in polipropilene copolimero, ideale per la coltivazione delle rose e delle piante da frutto. Con fori.
Pot Long Series in copolymer polypropilene, ideal for the cultivation of roses and fruit plants with holes.

Art.	Ø cm <=	Altezza cm Height cm	Litri Liter	Pcs. x Pallet
RS/2	14,5	17	2	7200
RS/3	16	19,5	3	*2500
RS/4	18	21,5	4	3600
RS/6	20	25,5	6	3000

*Pcs. x Palletbox

Colori disponibili
Available colors



Colori disponibili su richiesta per quantità
Available colors on demand for quantity



Polietilene con Fori | *Black in recycled polyethylene*

Art.	Ø cm <=	Altezza cm Height cm	Litri Liter	Pcs. x Pallet
RS 11/PE	25	28	11	1600



Ara

Vaso in Polipropilene Copolimero | *Pot in Copolymer Polypropylene*

Creato per la floricoltura e la coltivazione di piccole piante, leggero e dalla linea moderna.
 Con il bordo di piccole dimensioni, è il contenitore ideale per le piante che devono essere spedite su carrello.

*Created for floriculture and cultivation of small plants, it is light and with modern lines.
 With small size edge, it is the ideal container for plants that have to be dispatched on trolleys.*

Art.	Ø cm >	Ø cm <	Altezza cm Height cm	Litri Liter	Pcs. x Pallet
ARA 2,5	17	16	15,5	2,5	4000
ARA 3,5	19	18	18	3,5	3240
ARA 5,0	21	20	19	5	2700
ARA 7,0	23	22	21	7	2200
ARA 8,0	24	23	23	8	1600

Available colors
Colori disponibili

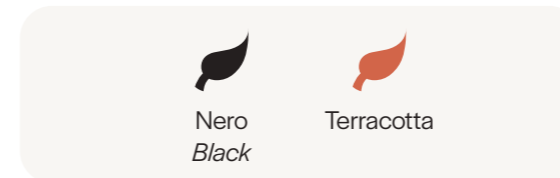

Colori disponibili su richiesta per quantità
Available colors on demand for quantity



Vaso Speciale per Agrumi Special Pot for Citrus Trees

Vaso in polietilene | Pot in Polyethylene

Vaso in polietilene rigenerato nero senza bordo e con croce sul fondo, ideale per la coltivazione degli agrumi.
Pot in recycled polyethylene, without rim and with crossed bottom, ideal for the cultivation of citrus trees.

Art.	Ø cm	Altezza cm Height cm	Litri Liter	Pcs. x Pallet
AG 15	15	18,5	2,7	2000*
AG 18	18	21,5	4	3600
AG 20	20	25,5	6,3	2400

*Pcs. x Palletbox



Colore disponibile
Available color



Nero
Black

Colore disponibile su richiesta
con maggiorazione di prezzo
Color available on request with price increase



Terracotta

Vaso per Palme | Special Pot for Palms

In Polipropilene Copolimero | Pot in Copolymer Polypropylene

Vaso con fondo studiato appositamente per la coltivazione delle palme.
Pot with a bottom properly studied for the cultivation of palms.

Art.	Ø cm	Altezza cm Height cm	Litri Liter	Pcs. x Pallet
PA 11	11	11	1	5600*
PA 14	14	14	2	6720
PA 19	19	19	4	3750
PA 25 (PELD)	25	25	10	1700

*Pcs. x Palletbox



Colore disponibile
Available color



Nero
Black

Colore disponibile su richiesta
con maggiorazione di prezzo
Color available on request with price increase



Terracotta

New Pot



In Polipropilene Copolimero | Pot in Copolymer Polypropylene

Vaso dalla speciale rifinitura satinata, ideale per la coltivazione delle orchidee.
Pot with a particular satin finishing, ideal for the cultivation of orchids.

Art.	Ø cm	Altezza cm Height cm	Litri Liter	Pcs. x Pallet
NP 10	14	16	1,6	*3072
NP 17	16,5	19,5	3	*1975
NP 20	25	25	6	3000

*Pcs. x Palletbox

Colore disponibile
Available color



Nero
Black

Colori disponibili | Available colors



Bianco
White



Terracotta



Verde
Green



Vaso Antlia | Antlia Pot Cover

Coprivaso in Polipropilene Copolimero | Pot cover in copolymer polypropylene

Coprivaso, con fori sotto, disponibile in tanti colori vivaci. Un ornamento indispensabile per abbellire le tue piante!
 Pot cover with holes on the bottom part available in many bright colors. An essential decoration to beautify your plants!

Art.	Ø cm	Altezza cm Height cm	Litri Liter	Pcs. x Pallet
AN 18	18	18	4	1200
AN 20	20	20	5	1350
AN 24	24	24	10	800
AN 30	30	30	18	360
AN 33	33	33	25	225

Colori disponibili | Available colors



Altri colori disponibili su richiesta per quantità.
 Other colors on demand for quantity.



Luna

Luna disponibile in tanti colori vivaci | Luna available in many bright colors

SAUCER INCLUDED | SAUCER INCLUDED

Art.	Lungh. cm Length cm	Largh. cm Width cm	Altezza cm Height cm	Litri Liter	Pcs. x Box
LUNA 40	40	20	20	12	12
LUNA 50	50	20	20	15	12
LUNA 60	60	20	20	18,5	12

Colori disponibili su richiesta per quantità
 Available colors on demand for quantity



Balconiera | Window Iron Planter

Supporto per cassette in ferro smaltato nero lucido con vernice epossodica.
 Bracket for flower box glossy black with epoxy paint.



Art.	Lungh. cm Length cm	Largh. cm Width cm	Altezza cm Height cm	Pcs. x Box
SULUNA 40	40	20	16	sfusi loose
SULUNA 50	50	20	16	sfusi loose
SULUNA 60	60	20	16	sfusi loose

ANTLIA LUNA



GARDEN



Cassetta Carina

Carina Rectangular Flower Box



La Cassetta CARINA è stata creata per rispondere a più necessità: può essere la copertura di una cassetta da produzione (vedi Cassetta Ercole) ma soprattutto, grazie alla sua linea versatile ed essenziale, può diventare un accessorio indispensabile per abbellire gli angoli di ogni terrazzo o giardino.

Carina was created to satisfy to multiple needs: it can be the cover of Box used for production (see ERCOLE Growing Box) but, above all, thanks to its versatile and simple line, it can become an essential accessory to adorn the corners of each terrace or garden.

Art.	Lungh. cm Lenght cm	Largh. cm Width cm	Altezza cm Height cm	Litri Liter	Pcs. x Pallet
CARINA 70	70	30	31	60	75
S/CARINA70	70	30	6,45		a piacere on demand

Colori disponibili
Available colors



Antracite
Anthracite



Terracotta

CARINA 70

Vedi cassetta Ercole | see Ercole Growing Box: pag.97



Colori disponibili | Available colors



Bordeaux



Bronzo
Bronze



Verde Lime
Green Lime



Nero
Black

S/CARINA70



Cassetta Libra | Libra Flower Box



La nuova cassetta LIBRA può essere utilizzata come una normale fioriera o come portavasi (può contenere tre vasi della linea Vega - Art. VE23) per poter creare composizioni con piante di differente varietà.

The brand new LIBRA flowerbox can be used as a normal flowerbox or as a cachepot. It can contain 3 pots of the Vega Line (Art. VE23). Ideal to create compositions with several plant varieties

Art.	Lungh. cm Lenght cm est. out - int. ins.	Largh. cm Width cm est. out - int. ins.	Altezza cm Height cm est. out - int. ins.	Litri Liter	Pcs. x Pallet
LIBRA	82/77	30,5/25,5	27,5/26,8	40	100



Sottovaso | Saucer

Art.	Lungh. cm Lenght cm	Largh. cm Width cm	Altezza cm Height cm	Pcs. x Pallet
SLIBRA 82	82	31	4	sfusi loose



Colori disponibili | Available colors



Antracite
Anthracite



Nero
Black



Bronzo
Bronze



Tortora
Dove Grey



Terracotta

LIBRA + VEGA

Vedi serie Vega | see Vega Collection Box: pag. 124/126



LIBRA



Maxi Cassetta | Maxi Flower box

Maxi cassetta in polipropilene copolimero stabilizzato ai raggi UV, ideale per l'arredo di terrazzi, strade e viali. Disponibili set di ruote per tutte e tre le misure.

Maxi flower-box in copolymeric polypropylene stabilized for the UV rays, ideal for the furnishing of patios, streets and paths. Set of wheels available for all the sizes.

Art.	Lungh. cm Length cm	Largh. cm Width cm	Altezza cm Height cm	Litri Liter	Pcs. x Pallet
MD 60	60	30	28	30	360
MD 80	80	35	33	50	90
MD 100	100	45	40	110	90

Colore disponibile | Available colors



Sottovaso | Saucer

Art.	Lungh. cm Length cm	Largh. cm Width cm	Altezza cm Height cm	Pcs. x Pallet
MF 60	60	30	6	a piacere on demand
MF 80	80	33	6,5	a piacere on demand
MF 100	100	41	7	a piacere on demand
MF 1	serie 4 ruote per trasporto set 4 wheels			a piacere on demand



Cassiopea

Cassetta Similcotto in Polipropilene Copolimero Flower Box Similcotto in Copolymeric Polypropylene

Cassetta in polipropilene copolimero stabilizzato ai raggi UV, ideale per l'arredo di balconi. Flower-box in copolymeric polypropylene stabilized for the UV rays, ideal for the furnishing of balconies.

Art.	Lungh. cm Length cm	Largh. cm Width cm	Altezza cm Height cm	Litri Liter	Pcs. x Pallet
D 40	40	20	16	8	900
D 50	50	20	16	10,5	900
D 60	60	20	16	12,5	900
D 80	80	20	16	14,5	600

Sottovaso | Saucer

Art.	Lungh. cm Length cm	Largh. cm Width cm	Pcs. x Pallet
F 40	40	20	sfusi loose
F 50	50	20	sfusi loose
F 60	60	20	sfusi loose

Colori disponibili | Available colors

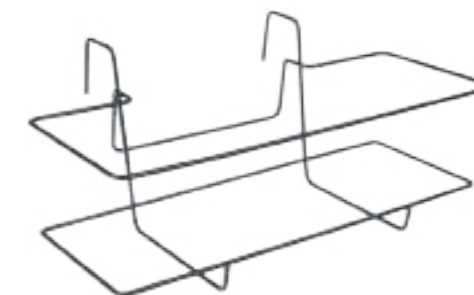

Balconiera | Window Iron Planter

Supporto per cassette in ferro smaltato nero lucido con vernice epossodica. Bracket for flower box glossy black with epoxy paint.

Art.	Lungh. cm Length cm	Largh. cm Width cm	Altezza cm Height cm	Pcs. x Box
SUD 40	37	18	16	sfusi loose
SUD 50	47	18	16	sfusi loose
SUD 60	57	18	16	sfusi loose



Mini-Cassiopea

Mini Flower Box in Copolymeric Polypropylene

Mini cassetta in copolimero stabilizzato ai raggi U.V., ideale per l'arredo di davanzali e ringhiere con sottocassetta ad incastro.

Mini flower-box in copolymer polypropylene stabilized for the U.V. rays, ideal for the furnishing of windows and railings, with joint saucer.

Art.	Lungh. cm Lenght cm	Largh. cm Width cm	Altezza cm Height cm	Litri Liter	Pcs. x Box
MC 20	20	11,5	11	1,6	110
MC 30	30	11,5	11	2,6	150
MC 40	40	11,5	11	3,6	100

Sottovaso | Saucer

Art.	Lungh. cm Lenght cm	Largh. cm Width cm	Altezza cm Height cm	Pcs. x Box
MS 20	20	11,5	2	110
MS 30	30	11,5	2	150
MS 40	40	11,5	2	100

Colori disponibili | Available colors



SOTTOVASO | SAUCER



MINI CASSIOPEA

Pegaso

Vaso Similcotto in Polipropilene Copolimero Pot Similcotto in Copolymeric Polypropylene

Vaso prodotto in polipropilene copolimero, stabilizzato ai raggi UV, ideale per tutti gli impieghi nel giardinaggio.

Pot Similcotto in Copolymeric Polypropylene, stabilized to the U.V. rays, ideal for all kinds of gardening employments.

Art.	Ø cm <	Altezza cm Height cm	Litri Liter	Pcs. x Pallet
P 14	14	11	1,5	6000
P 16	16	14	2,5	5000
P 18	18	16	3,5	3600
P 20	20	19	4,5	3000
P 22	22,5	21	6	2000
P 25	25	23,5	8	2000
P 28	28	26	11	1300
P 30	30	28,5	15	1000
P 33	33	31	19	850
P 37	37	33	25	650
P 44	44	38	40	360
P 54	54	46	80	220
P 60	59	52	105	120



Sottovaso | Saucer

Art.	Ø cm >	Pcs. x Box
S 15 (P14-P16)	15	100
S 17 (P18-P20)	17	100
S 20 (P22-P25)	20	100
S 25 (P28-P30)	25	100
S 28 (P33)	28	100
S 32 (P37)	32	50
S 38 (P44)	38	25
S 40 (P54)	40	25



Colori disponibili su richiesta per quantità per P28 - P33 - P44

Available colors on demand for quantity for P28 - P33 - P44

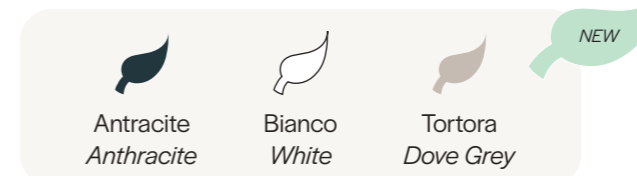

Orione

Ciotola Similcotto in Polipropilene Copolimero *Bowl Similcotto in Copolymeric Polypropylene*

Questa ciotola, in polipropilene copolimero stabilizzato ai raggi UV, è ideale per la floricoltura e il garden.
Bowl in copolymer polypropylene stabilized to the UV rays, ideal for the floriculture and gardening.

Art.	Ø cm >	Ø cm <	Altezza cm Height cm	Litri Liter	Pcs. x Pallet
O 19	21,5	19,5	9,7	2	11000
O 20	22	20	12	3	5000
O 25	27,5	25	16	6	3000
O 30	33	30	19	8	1800
O 35	38	35	22	14	1300
O 40	44	40	26,5	24	600
O 45	50	45	28,2	35	400

Sottovaso | Saucer

Art.	Ø cm >	Pcs. x Box
*G 19	17	240
*G 20	18	150
*G 25	22	150
*G 30	26	100
S32 (O35/O40)	32	50

*sottociotola da G19 a G30 a incastro
**saucers from G19 to G30 with clips*

Colore disponibile | Available colors

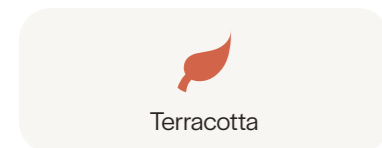

Su richiesta, per quantità,
è possibile realizzare
qualsiasi tipo di colore.

*For minimum order quantities,
it is possible to manufacture
any customized color.*



SOTTOVASO
SAUCER



Giove

Ciotola Similcotto in Polipropilene Copolimero *Bowl Similcotto in Copolymeric Polypropylene*

La ciotola Giove è ideale per la coltivazione in special modo di piante bonsai.
Giove bowl is ideal for growing plants and especially bonsai.

Art.	Ø cm >	Ø cm <	Altezza cm Height cm	Litri Liter	Pcs. x Pallet
GIO 60	60	51	25	40	240
GIO 68	68	58,5	29	65	150
GIO 75	75	66	30	80	70
GIO 90	90	80	38	145	60

Colori disponibili | Available colors



Colori disponibili su richiesta per quantità
Available colors on demand for quantity

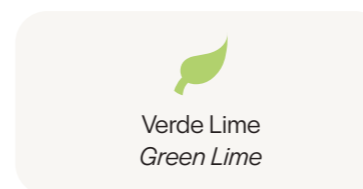

Andromeda



Ciotola Similcotto in Polipropilene Copolimero Bowl Similcotto in Copolymeric Polypropylene

Ciotola in polipropilene copolimero stabilizzato ai raggi UV, adatta alle composizioni floreali, soprattutto nelle misure grandi.
Bowl in copolymeric polypropylene, ideal for the floral composition, above all in big sizes.

Art.	Ø >	Ø <	Altezza cm Height cm	Litri Liter	Pcs. x Pallet
T 17	17	15,5	6,5	0,8	*3630
T 21	21	19,2	9,5	2	5500
T 28	28	26	11,3	4	5000
T 35	35	32	13	7,5	2400
T 40	40	37	15	11,5	900
T 50	50	46,8	19	24	600
T 60	60	56	24,5	44	250
T 80	80	74	28,7	90	100

*Pcs. x Palletbox



Sottovaso | Saucer

Art.	Ø cm >	Pcs. x Box
V 17*	14,30	150
V 21*	16,50	150
V 28*	19,50	150
V 35	24	90
V 40	28,50	80
V 50	34	50
S40 (T60)	40	25

Sottociotola dal V17 al V28 ad incastro

*Saucer from V17 till V28 with "Clips"

Dal V35 al V50 "Piatto"

Saucer V35 till V50, plate without clips



ANDROMEDA



SOTTOVASO SAUCER

Colore disponibile | Available color

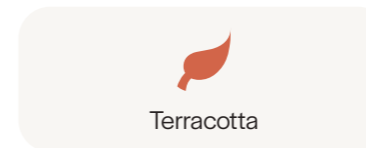

Colori disponibili su richiesta per quantità
Available colors on demand for quantity

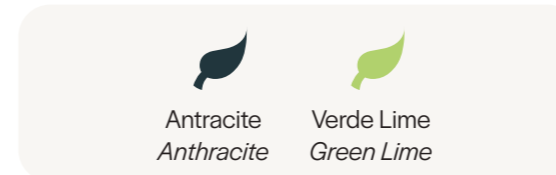

per T21 - T28 - T35
for T21 - T28 - T35



Ariete

Ciotola Similcotto in Polipropilene Copolimero *Bowl Similcotto in Copolymeric Polypropylene*

Ciotola similcotto in polipropilene copolimero stabilizzato ai raggi UV, dalla linea semplice ed essenziale.
Bowl in copolymer polypropylene, stabilized for the UV rays, with an essential and simple design.

Art.	Ø cm >	Ø cm <	Altezza cm Height cm	Litri Liter	Pcs. x Pallet
E 16	16	14,5	7,5	0,9	*5000
E 19	19	17,3	11,3	1,5	*2400
E 22	22	20,3	11,6	2,6	4500
E 25	25	23	12,7	3,8	3200
E 27	27	25,3	13,6	4,9	2600
E 31	31	29,2	16	7,8	1500

*Pcs. x Palletbox

Sottovaso | Saucer

Art.	Ø cm >	Pcs. x Box
*Z 16	13	300
*Z 19	15	300
*Z 22	17,5	180
*Z 25	19,5	140
*Z 27	21,5	120

*Sottociotola ad incastro
*Saucer with "Clips"



ARIETE



SOTTOVASO
SAUCER

Sirio

Similcotto in Copolymeric Polypropylene

Piccola ciotola in polipropilene copolimero stabilizzata ai raggi UV, ideale per la floricoltura stagionale.
Small bowl in similcotto copolymeric polypropylene stabilized to the UV rays, ideal for the seasonal floriculture.

Art.	Ø cm <	Altezza cm Height cm	Litri Liter	Pcs. x Pallet
SR 16	16	11,5	1,6	*4130
SR 18	18	12,5	2,2	7200

*Pcs. x Palletbox

Sottovaso | Saucer

Art.	Ø cm >	Pcs. x Box
*Z 16	13	300
*Z 19	15	300

*Sottociotola ad incastro
*Saucer with "Clips"

Colori disponibili | Available colors



Bianco
White



Terracotta



SIRIO



SOTTOVASO
SAUCER



Ganci per Orione, Ariete, Andromeda e Sirio

Hooks for Orione, Ariete, Andromeda and Sirio

Art.	Altezza cm Height cm	Pcs. x box
GG 25	25	200
GG 35	35	200
GG 50	50	400



ORIONE



ANDROMEDA



ARIETE



SIRIO

NEW
 Vedi Pegaso e Andromeda alle pag.149 e 152
 See Pegaso and Andromeda pag. 149 and 152



VASO P.B. | POT P.B.

Vasi vivaio in polipropilene copolimero dal fondo a croce ideale per la floricoltura.
Nursery pots in copolymeric polypropylene, with typical crossed bottom, ideal for the floriculture.

Art.	Ø cm <	Altezza cm Height cm	Litri Liter	Pcs. x Pallet
PB 15	17,5	15,2	2,5	6300
PB 18	18	18	3,5	4500
PB 20	20	20	4,6	4200
PB 22	22	22	6,5	2500
PB 24	24	24	8,5	2500

Colori disponibili | Available colors



Nero
Black



Terracotta



Flori

Vaso professionale per la floricoltura e la coltivazione di piante aromatiche. | Professional pot for floriculture and aromatic plants.

Art.	Ø cm	Altezza cm Height cm	Litri Liter	Pcs. x Box	Box x Pallet
FLORI 10/N	10	8	0,41	1872	16
FLORI 10/TC	10	8	0,41	1872	16
FLORI 12/N	12	9,4	0,66	1140	16
FLORI 12/TC	12	9,4	0,66	1140	16
FLORI 14/N	14	11,3	0,98	804	16
FLORI 14/TC	14	11,3	0,98	804	16

Colori disponibili | Available colors



Nero
Black



Terracotta



Florì Vaso Quadro | Florì Square Pot göttinger

Art.	Lungh. cm Length cm	Largh. cm Width cm	Altezza cm Height cm	Litri Liter	Pcs. x Box	Box x Pallet
Q FLORI7	7	7	8	0,35	2000	16



Big Florì göttinger

Art.	Ø cm	Altezza cm Height cm	Litri Liter	Pcs. x Pallet
BFLORI 15N	15	12	1,5	9840
BFLORI 15TC	15	12	1,5	9840
BFLORI 17N	17	13	2	6970
BFLORI 17TC	17	13	2	6970
BFLORI 19N	19	15	3	4125
BFLORI 19TC	19	15	3	4125
BFLORI 23N	23	18	5	3060
BFLORI 23TC	23	18	5	3060
BFLORI 26N	26	21	7,5	1750
BFLORI 26TC	26	21	7,5	1750
BFLORI 29N	29	21,5	10	1375
BFLORI 29TC	29	21,5	10	1375

Con porta etichette
With label holder



Colori disponibili | Available colors



Nero
Black



Terracotta

FLORÌ



Olanda

Vaso Per Trasporto Fiori Recisi | *Pot For The Carriage of Cut Flowers*

Polipropilene senza fori | *in Copolymeric Polypropylene without holes.*

Art.	Ø cm <	Altezza cm Height cm	Litri Liter	Pcs. x Pallet
C 24	24	20,5	6	2500
C24/A	24	26	9	1500
C26	26	27	10	2000
C29	29,2	35	14	1500
C30	30	24	13	1800



Art.	Lungh. cm Length cm	Largh. cm Width cm	Altezza cm Height cm	Litri Liter	Pcs. x Pallet
C 28	27,3	24,7	28	17	960



Vaso a Muro | *Wall Pot*



Art.	Ø cm <	Altezza cm Height cm	Pcs. x Pallet
H 24	24	21,5	1820

Colori disponibili | *Available colors*



Bianco
White



Terracotta



Telo antialga | *Anti - Mulch Covering*

Art.

Rotoli da metri lineari 100 - gr. 105 al mq.
Each roll 100 linear meter - gr. 105 al mq.

Altezze disponibili mt. 1,05 - 1,65 - 2,10 - 2,62 - 3,30 - 4,20 - 5,25
Available heights mt. 1,05 - 1,65 - 2,10 - 2,62 - 3,30 - 4,20 - 5,25



Colore disponibile
Available color

Colore disponibile su richiesta
Available color on demand



Nero
Black



Verde
Green

Chiodi in ferro zingato per fissaggio telo antialga | *Steel nails for antimulch covering*

Art. Altezza cm | Height cm



Chiodi - sfusi | Nails - loose 27

Chiodi in plastica per fissaggio telo antialga | *Plastic nails for antimulch covering*

Art. Altezza cm | Height cm x Box



Chiodi in plastica | Plastic nails 19 1000

Cavallotti ferma telo antialga | *Clips for antimulch covering*

Art. Altezza cm | Height cm x box

Cavallotti bruniti | Clips not galvanized 10x25 150

Cavallotti zincati | Clips galvanized 10x25 150

Cavallotti bruniti | Clips not galvanized 10x45 50



Carrelli porta Fenice e porta Mastelli *Trolley for Fenice and Big Containers*

Carrello in acciaio zincato | *Trolley in Galvanized Steel*

Art.	Massimo ingombro cm Maximum space cm	Ruote Wheels
CAR 43	43	-
CAR 47	47/50	13"
CAR 55	55/57	15"
CAR 60*	60/62	-
CAR 65**	65	-
SERCAR	62	-

* Grande con aggancio rapido | *Big trolley with fast hooking

** Grande con catena | **Big trolley with chain

CAR 43



CAR 47



CAR 55



CAR 60



CAR 65



SERCAR



Carrello Portavasi | *Trolley for Pots*

Art.	Massimo ingombro cm Maximum space cm	Pedana Footboard
CAR 500	90	*50x50
CAR 700	140	**70x70

* Pedana con piedino | *Footboard with foot

** Pedana con ruotina | *Footboard with small wheel



Carrelli Portavasi | *Trolley for Pots*

Carrello in acciaio zincato con ruote annesse
Trolley in galvanized steel with annex wheels

Art.	Lungh. cm Length cm	Largh. cm Width cm
CV 40	40	40
CV 50	50	50
CV 60	60	60



Carrelli Portavasi | *Trolley for Pots*

Carrello Zincato | *Trolley in Galvanized Steel*

Art.	Lungh. cm Length cm	Largh. cm Width cm
CARRE 4	200	80



Portapacchi | *Small parcel trolley*

Carrello in acciaio zincato | *Trolley in Galvanized Steel*

Art.	Massimo ingombro cm Maximum space cm	Pedana Footboard
PORTAP	65	45x25
PORTAG	75	50x30

Con ruote piene | *With solid wheels.*



CONDIZIONI GENERALI DI VENDITA

Le condizioni di vendita a seguire, salvo deroghe specifiche concordate per iscritto, regolamentano tutti i contratti di compravendita tra le parti.

1. OGGETTO DELLA VENDITA

1.1 Tutti i prodotti presenti nel catalogo di Nuova Pasquini & Bini S.p.A. possono essere oggetto di vendita. I soggetti intenzionati all'acquisto dei prodotti presenti nel catalogo di Nuova Pasquini & Bini S.p.A. sono comunque tenuti, prima di formulare l'ordine di acquisto, a verificare, tramite richiesta diretta alla società venditrice, che l'articolo interessato sia ancora in produzione.

1.2 L'Acquirente dichiara di conoscere e accettare pesi, dimensioni, forme, materiale e tutti i dati tecnici indicati da Nuova Pasquini e Bini S.p.A. sul catalogo o nelle comunicazioni scritte. Tuttavia, dimensioni, capacità e colori dei vasi riportati su catalogo sono da considerarsi come dati puramente indicativi in quanto le materie plastiche sono soggette a ritiro. Inoltre, le materie prime impiegate per la produzione, anche dello stesso articolo, possono essere di tonalità lievemente differenti.

1.3 La Nuova Pasquini e Bini S.p.A. si riserva il diritto di apportare modifiche alle caratteristiche dei prodotti o di cessarne la produzione, nell'ottica di migliorarne la qualità, senza nessun preavviso, escludendo qualsiasi diritto dell'Acquirente a pretendere un risarcimento.

1.4 Le offerte e/o la documentazione tecnica allegate ad esse sono ad uso esclusivo dell'Acquirente. E' vietato renderle accessibili a terzi, anche parzialmente, senza previa autorizzazione scritta di Nuova Pasquini e Bini S.p.A.

2. GARANZIE

2.1 La Nuova Pasquini e Bini S.p.A. consegna merci conformi alle leggi vigenti in Italia. L'acquirente accetterà che la merce sia conforme alle leggi del paese in cui egli opera ed informerà prontamente, comunque prima della spedizione, la Nuova Pasquini e Bini S.p.A. su eventuali modifiche da apportare a merci e/o a imballaggi in considerazione di quanto previsto e disciplinato dalla normativa di legge vigente nel suo paese.

2.2 Nel caso venga omessa o ritardata la comunicazione di cui al punto 2.1, Nuova Pasquini & Bini S.p.A. sarà esonerata da qualsivoglia responsabilità per eventuali danni subiti dall'Acquirente e per ogni eventuale sanzione che potrà essere a costui comminata da Autorità del suo Paese, conseguente all'impiego dei prodotti fabbricati dalla venditrice e l'Acquirente non potrà pretendere alcun risarcimento o rimborso da Nuova Pasquini & Bini S.p.A.

3. PREZZI

3.1 I prezzi di Listino si intendono Franco ns. stabilimento di Altopascio (LU), salvo diverso accordo scritto, e sono espressi in Euro. L'IVA non è compresa nel prezzo e sarà esposta in fattura separatamente in base all'aliquota vigente a tale data.

3.2 I prezzi di Listino potranno variare senza preavviso, in qualsiasi momento, a causa della situazione instabile del mercato delle materie prime e di quello valutario.

4. ORDINI

4.1 Gli ordini si intendono accettati da Nuova Pasquini e Bini S.p.A. solo dopo esplicita conferma. Gli ordini, una volta confermati, impegnano l'Acquirente e non possono essere annullati o modificati senza una comunicazione iscritta che deve pervenire alla Nuova Pasquini e Bini S.p.A. mediante fax o via e-mail.

4.2 La Nuova Pasquini e Bini S.p.A. si riserva la facoltà di annullare gli ordini che a causa di avvenimenti imprevedibili e indipendenti dalla propria volontà ne rendano impossibile o eccessivamente onerosa l'esecuzione. In tali casi, l'Acquirente non avrà diritto al rimborso e/o risarcimento del danno, fatta salva la restituzione di acconti già versati relativi a merci non ancora consegnate.

5. CONSEGNA E SPEDIZIONI

5.1 I termini di spedizione e di consegna non hanno valore tassativo e devono intendersi puramente indicativi, senza impegno alcuno per la Nuova Pasquini e Bini S.p.A.

5.2 La merce viaggia sempre a rischio dell'acquirente anche se venduta franco destino. L'Acquirente non potrà esigere alcun risarcimento, rimborso e/o indennizzo da Nuova Pasquini e Bini S.p.A. per eventuali danni subiti dalla merce durante la spedizione.

6. DENUNCIA DEI VIZI E RISERVA DI PROPRIETÀ

6.1 Il cliente, al momento della consegna, ha l'onere di procedere immediatamente alla verifica della merce.

6.2 Le contestazioni relative ad ogni fornitura non saranno accettate trascorsi 8 (otto) giorni dal ricevimento della merce. Eventuali contestazioni inerenti alla quantità o qualità dei colli devono essere trascritte sui relativi documenti di trasporto all'atto della consegna o comunque entro 48 ore lavorative alla consegna della merce e trasmesse tempestivamente alla Nuova Pasquini e Bini S.p.A. via e-mail o fax. L'omessa o ritardata contestazione della quantità e/o tipologia della merce consegnata non pregiudicherà o limiterà in alcun modo il diritto di Nuova Pasquini & Bini S.p.A. ad esigere l'integrale pagamento del corrispettivo della fornitura.

6.3 La restituzione delle merci necessita della preventiva autorizzazione scritta della Nuova Pasquini e Bini S.p.A.

6.4 Nuova Pasquini e Bini S.p.A. non accetterà la restituzione di merci trascorsi (2) due mesi dalla data di consegna.

6.5 Il diritto di proprietà sulla merce oggetto di vendita è di Nuova Pasquini e Bini S.p.A. fino al momento dell'integrale pagamento del corrispettivo da parte dell'Acquirente.

7. CONDIZIONI DI PAGAMENTO

7.1 Il corrispettivo concordato deve essere corrisposto esclusivamente presso il domicilio della Nuova Pasquini e Bini S.p.A. e con pagamenti eseguiti nei termini e nei modi stabiliti all'atto dell'ordine. Ogni diversa forma di pagamento dovrà essere autorizzata dalla Nuova Pasquini e Bini S.p.A. con dichiarazione scritta.

7.2 I ritardi nei pagamenti, in qualunque forma siano espressi, danno diritto alla Nuova Pasquini e Bini S.p.A. a procedere all'addebito degli interessi di mora secondo legge vigente.

8. SOSPENSIONE DELLE FORNITURE

8.1 La Nuova Pasquini e Bini S.p.A. si riserva il diritto di recedere dal contratto o sospendere e interrompere le consegne qualora di verificassero variazioni di qualsiasi natura nella composizione sociale, nella forma e nella struttura, nella consistenza e alla capacità commerciale della ditta committente, come pure in caso di protesti o di ritardo nei pagamenti stabiliti.

8.2 Nuova Pasquini & Bini S.p.A. avrà diritto di sospendere le forniture di merci in corso, destinate all'Acquirente, nel caso in cui costui abbia omesso o ritardato il pagamento di somme a lei dovute. Le forniture da parte di Nuova Pasquini & Bini S.p.A. riprenderanno solo dopo che siano stati pagati tutti i crediti insoluti.

9. FORO COMPETENTE

9.1 Per qualsiasi controversia il foro competente è quello di LUCCA (Italia).

10. COMUNICAZIONI

10.1 Ogni comunicazione e/o ordine merce destinato alla Nuova Pasquini e Bini S.p.A. si intende validamente trasmessa solo se pervenuta esclusivamente a mezzo posta all'indirizzo Nuova Pasquini e Bini S.p.A. – Località Tei – Zona Industriale “La Galeotta” snc 55011 Altopascio (LU) Italy a mezzo posta elettronica info@pasquiniiebini.it o pasquiniiebini@legalmail.it a mezzo fax 0039 0583 269115.

11. TRATTAMENTO DEI DATI PERSONALI

11.1 L'Acquirente dichiara di aver preso visione dell'informativa in materia di trattamento e protezione dei dati personali predisposta da Nuova Pasquini & Bini S.p.A. in base al Regolamento UE 2016/679 (GDPR) e al Decreto Legislativo 196/2003, di aver compreso le finalità e basi giuridiche del trattamento dei dati personali e di aver compreso quali siano i diritti riconosciuti all'interessato dalla suddetta normativa.

Ai sensi e per gli effetti di cui all'art.1341 c.c. l'Acquirente dichiara di aver letto attentamente le clausole sopra riportate ai numeri 1) Oggetto della vendita; 2) Garanzie; 3) Prezzi; 4) Ordini; 5) Consegne e Spedizioni; 6) Denuncia dei vizi e riserva di proprietà; 7) Condizioni di Pagamento; 8) Sospensione delle forniture; 9) Foro competente; 10) Comunicazioni; 11) Trattamento dei dati personali.

NOTES

GENERAL CONDITIONS OF SALE

The general conditions of sale, save for any specific exceptions agreed in writing, shall regulate all the present and future purchase agreements between the parties.

1. SUBJECT OF THE SALES

1.1 All the products in Nuova Pasquini&Bini's S.p.A. catalogue can be sold.

The person, who is interested in purchasing any Nuova Pasquini&Bini's S.p.A. product, before formulating the purchase order, has to verify through a direct inquiry to the Company, if this item is still in production.

1.2 The Client knows and hereby accepts weights, dimensions, shapes, materials and all the technical data sheets indicated by Nuova Pasquini&Bini S.p.A. in the catalogue or by written communications. However, dimensions, capacity and colors of pots are merely indicative because plastic materials are subject to shrink. Furthermore, the raw material used in production, even for same article, might slightly be in different shades.

1.3 Nuova Pasquini&Bini S.p.A. reserves the right to implement changes to the characteristics of the products or cease production, in order to improve the quality of products, without prior advice, it being understood that the buyer shall not be entitled to any right whatsoever.

1.4 The offers and/or the technical documentation enclosed to them are for the exclusive use of the Buyer. It is forbidden to make them accessible to third parties, even partially, without the prior written authorization by Nuova Pasquini&Bini S.p.A.

2 WARRANTIES

2.1 Nuova Pasquini and Bini delivers goods to the Buyer that are in conformity with the Italian law. The Buyer verifies that the goods are in compliance with the Laws of the Country in which it operates and shall promptly, before the delivery of the goods, inform Nuova Pasquini&Bini S.p.A., if any appropriate modifications to the goods or to the packaging have to be made, in consideration of what is expected and governed by the law in force in your country.

2.2. In case the communication may be omitted or delayed concerning the above point 2.1, Nuova Pasquini&Bini S.p.A. will be exempted for any damage suffered by the buyer and for any penalty that may be imposed on him by the Authority of his country. As a result of the use of the products manufactured by the seller, the Buyer cannot claim any compensation or refund from Nuova Pasquini&Bini S.p.A.

3. PRICES

3.1 Prices are to be considered EX WORKS and are quoted in Euros, unless agreed in writing. VAT is not included in the price.

3.2 Prices may vary without any notice, at any time, due to the unstable situation of raw material as well as market currency.

4. ORDERS

4.1 Orders shall be considered accepted by Nuova Pasquini&Bini S.p.A. only after explicit confirmation. Orders, once confirmed, are binding for the buyer and cannot be cancelled or modified without a written communication which must be sent to Nuova Pasquini&Bini S.p.A. by fax or e-mail.

4.2 Nuova Pasquini&Bini S.p.A. has the right to cancel orders due to unforeseeable events which will make it impossible or uneconomical to fulfill. In this circumstance, the buyer shall not be entitled to reimbursement and or compensation for the damage. It will be return the deposit for the goods which are still not delivered.

5. DELIVERY AND TRANSPORTATION TERMS

5.1 Any delivery and shipping dates indicated are to be considered purely indicative and not as mandatory, without any commitment by Nuova Pasquini&Bini S.p.A.

5.2 The goods are always carried at buyer's risk, even when they are sold in free delivered terms. The buyer will not be able to claim any compensation, refund and or compensation from Nuova Pasquini&Bini S.p.A. for any goods which are damaged during the shipment.

6. WARRANTY

6.1 Upon deliver, the Buyer shall immediately inspect the goods.

6.2 Claims for defects and nonconformity of the delivered goods will not be accepted after 8 (eight) days from the receipt of the goods and in any case no later than the terms established by the law on delivery. Any claims about the quantity or quality of the packages have to be marked on the relevant delivery documents immediately or anyhow not beyond a 48 (forty-eight) working hours after delivery of the goods and promptly sent to Nuova Pasquini e Bini S.p.A. by e-mail or fax. The delayed or failure notification in quantities and or type of goods delivered will not affect or limit in any way the right of Nuova Pasquini&Bini S.p.A. to demand full payment for the supply.

6.3 Return of the goods is only possible upon prior written authorization from Nuova Pasquini&Bini S.p.A.

6.4 Nuova Pasquini&Bini S.p.A. shall not accept restitution of goods after 2 (two) months from delivery.

6.5 Nuova Pasquini&Bini S.p.A. has the right of ownership of the goods which are sold until the full payment is made by the buyer.

7. PAYMENT CONDITIONS

7.1 The agreed payment have to be paid exclusively to Nuova Pasquini&Bini S.p.A. within the terms and form established at the time of the order. Any different form of payment have to be authorized by Nuova Pasquini&Bini S.p.A. with a written declaration.

7.2 The delays of any kind of payments shall entitle the Nuova Pasquini&Bini S.p.A. to debit the interest on arrears according to the law in force.

8. SUSPENSION OF DELIVERIES

8.1 Nuova Pasquini&Bini S.p.A. reserves the right to withdraw from the contract or suspend and interrupt deliveries if there are any changes of any nature in the corporate composition, form and/or structure, consistency and commercial capacity of the buyer, as well as in the event of protests or delay in payments established.

8.2 Nuova Pasquini&Bini S.p.A. has the right to suspend any ongoing supply to the Buyer, in the event that he has omitted or delayed any payment. All the supplies by Nuova Pasquini&Bini S.p.A. will resume only after all the outstanding invoices have been paid.

9. COMPETENT COURT

9.1 For any controversy the place of jurisdiction is Lucca.

10. FINAL CONDITIONS

10.1 Any communication and/or sales order to Nuova Pasquini&Bini S.p.A. are considered to be duly made when addressed to: Nuova Pasquini&Bini S.p.A. – Località Tei – Zona Industriale “La Galeotta” snc 55011 Altopascio (LU) Italy or email address info@pasquini&bini.it or fax 0039 0583 269115.

11. USE OF PERSONAL DATA

11.1 The buyer declares to have read the information on the processing and protection of personal data prepared by Nuova Pasquini&Bini S.p.A. under EU Regulation 2016/679(GDPR) and legislation Nr. 196/2003. The Buyer also have understood the purposes and legal bases of the processing of personal datas and what right are granted to the data subject by the aforementioned legislation.

Pasquini&Bini
where your roots are safe

Nuova Pasquini & Bini S.p.A.
Partita IVA 01833370461
Cod. Fisc. 01211640477
Cap. Soc. 1.500.000,00 Euro int. vers.
REA 154420 CCIAA LUCCA



Nuova Pasquini & Bini S.p.A.

Località Tei - Zona Industriale La Galeotta
Altopascio (LU), ITALY

Tel. +39 0583 264656 - Fax +39 0583 269115

www.pasquiniebini.com - info@pasquiniebini.it